



**WindSonic™**

**GILL**

User Manual

Ultrasonic Anemometer

Doc No: 1405-PS-0019

Issue 25



APPLIES TO WINDSONIC OPTION 1-3 UNITS SUPPLIED FROM MARCH 2016  
WITH SERIAL NUMBERS 16110001 ONWARDS AND  
WITH FIRMWARE 2368-110-01 ONWARDS.

APPLIES TO WINDSONIC 75 OPTION 1, 2 and 3 UNITS  
SUPPLIED WITH FIRMWARE 2368-107-01

APPLIES TO OPTION 4 SDI-12 UNITS FROM JUNE 2011  
WITH SERIAL NUMBERS 11220007 ONWARDS.

Gill Instruments Limited  
Saltmarsh Park, 67 Gosport Street, Lymington,  
Hampshire, SO41 9EG, UK  
Tel: +44 1590 613500, Fax: +44 1590 613555  
Email: [anem@gillinstruments.com](mailto:anem@gillinstruments.com) Website: [www.gillinstruments.com](http://www.gillinstruments.com)

## Contents

1	FOREWORD	5
2	INTRODUCTION	5
3	FAST TRACK SET-UP	5
4	PRINCIPLE OF OPERATION	6
5	SPECIFICATION	8
6	PRE-INSTALLATION	10
6.1	EQUIPMENT SUPPLIED	10
6.1.1	<i>WindSonic Part Numbers</i>	10
6.2	PACKAGING	11
6.3	INSTALLATION REQUIREMENTS	11
6.4	CABLE ASSEMBLY	12
7	INSTALLATION	16
7.1	INSTALLATION GUIDELINES	16
7.2	BENCH SYSTEM TEST	17
7.3	ELECTRICAL	17
7.3.1	<i>Cable</i>	17
7.3.2	<i>Power supply</i>	18
7.4	CONNECTING TO A PC USING RS232 (OPTION 1 SENSOR)	19
7.5	CONNECTING WINDSONIC OPTION 2 OR 3 SET FOR DEFAULT RS422 TO A PC USING AN RS232 SAFE MODE CONNECTION.	20
7.6	CHANGING AN OPTION 2 OR 3 SENSOR SET FOR RS232 BACK TO RS422.	20
7.7	CONNECTING TO A GILL WINDDISPLAY	21
7.8	CONNECTING TO A PC USING RS422 (OPTION 2 OR 3)	22
7.9	USING RS485 (2 WIRE POINT TO POINT) WITH OPTION 2 OR 3 UNITS	23
7.10	USING THE ANALOGUE OUTPUT (OPTION 3)	24
8	Mechanical	25
8.1	ORIENTATION	25
8.1.1	<i>Alignment</i>	25
8.1.2	<i>Mounting</i>	25
9	MESSAGE FORMATS	27
9.1	GILL FORMAT– POLAR, CONTINUOUS (DEFAULT FORMAT)	27
9.2	GILL FORMAT – UV, CONTINUOUS	30
9.3	GILL FORMAT – POLLED (POLAR OR UV)	31
9.4	NMEA FORMAT (NMEA STATUS CODES)	32
9.5	NMEA FORMAT (GILL STATUS CODES)	33
9.6	GILL FORMAT – TUNNEL MODE (UU, CONTINUOUS)	33
9.7	ANALOGUE OUTPUTS AND OPTIONS	34
9.7.1	<i>Voltage or Current output</i>	34
9.7.2	<i>Analogue Output Modes</i>	34
9.7.3	<i>Polar mode direction wraparound</i>	34
9.7.4	<i>Wind Speed scaling</i>	35
9.7.5	<i>Tunnel mode</i>	35
9.7.6	<i>Analogue Output Rate</i>	35
9.7.7	<i>Disabled outputs</i>	35
9.7.8	<i>Analogue Output Conditions</i>	35
9.7.9	<i>Low wind speeds (below 0.05 m/s).</i>	36

9.7.10	<i>Error condition reporting</i>	36
10	CONFIGURING	39
10.1	WIND	39
10.2	WINDVIEW	43
10.3	CONFIGURING USING HYPERTERMINAL	48
10.4	ENTERING CONFIGURATION MODE	48
10.5	RETURNING TO MEASUREMENT MODE	48
10.6	CHECKING THE CONFIGURATION	49
10.7	CHANGING A SETTING	49
10.7.1	<i>Command List</i>	50
<i>Bx - Baud rate</i>		51
<i>Cx - Analogue settings</i>		51
<i>Dx - Diagnostic and Configuration Command (See Section 10.8)</i>		51
<i>Ex - Communications Protocol</i>		51
<i>Fx - Data and parity options</i>		52
<i>Gx - (To be allocated for future developments)</i>		52
<i>Hx - Power-up Message</i>		52
<i>Kxx to Kxxx - Minimum Direction Velocity</i>		53
<i>Lx - Message Terminator</i>		53
<i>Mx to Mxx - Message Format</i>		53
<i>Nx - Node Address</i>		53
<i>Ox - ASCII Output Format</i>		54
<i>Px to Pxx - Output Rate</i>		54
<i>Q - Measurement Mode</i>		54
<i>Sx - Analogue Output Range</i>		55
<i>Tx - Analogue Output Type (Voltage or Current)</i>		55
<i>Ux - Output Units</i>		55
<i>Yx - Analogue Output, Error Status Condition</i>		55
10.8	CONFIGURATION / DIAGNOSTIC INFORMATION	56
11	MAINTENANCE & FAULT-FINDING	57
11.1	CLEANING	57
11.2	SERVICING	57
11.3	FAULT FINDING	57
11.4	RETURNING UNIT	58
11.5	STATUS	58
12	TESTS	58
12.1	BENCH TEST	58
12.2	SELF-TEST (STILL AIR)	59
12.3	CALIBRATION	59
13	APPENDICES	60
13.1	GLOSSARY & ABBREVIATIONS	60
13.2	GUARANTEE	60
13.3	WINDSONIC OPTIONS 1, 2, 3 AND 4	61
ELECTRICAL CONFORMITY		61
14	SDI-12 WindSonic	62
14.1	WINDSONIC OPTION 4 SPECIFICATION	62
14.2	CABLE TYPE	63
14.3	CABLE LENGTH	63

14.4	CONNECTING TO AN SDI-12 INTERFACE (OPTION 4)	63
14.5	SDI-12 COMMANDS	64
14.6	GILL OUTPUT MESSAGE FORMAT	67
14.7	SDI-12 STATUS CODES	67
14.8	SDI-12 SAFE MODE	68
14.9	WINDSONIC OPTION 4 ELECTRICAL CONFORMITY	69

## 1 FOREWORD

Thank you for purchasing the WindSonic manufactured by Gill Instruments Limited. The unit has no customer serviceable parts and requires no calibration or maintenance. To achieve optimum performance we recommend that you read the whole of this manual before proceeding with use. Do NOT remove black "rubber" transducer caps.

Gill products are in continuous development and therefore specifications may be subject to change and design improvements without prior notice.

The information contained in this manual remains the property of Gill Instruments and should not be copied or reproduced for commercial gain.

## 2 INTRODUCTION

The Gill WindSonic wind sensor is a very robust, lightweight unit with no moving parts, outputting wind speed and direction. The units of wind speed, output rate and formats are all user selectable.

The WindSonic can be used in conjunction with a PC, data logger or other device, provided it is compatible with one of the standard communication formats provided by the WindSonic.

WindSonic (option 2 or 3 only) is designed to connect directly to the Gill WindDisplay unit to provide a complete wind speed direction system.

WindSonic (options 1, 2 and 3) may be configured using Wind software which is available, free of charge, from the Gill website [www.gillinstruments.com](http://www.gillinstruments.com). The output message format can be configured in Gill format, in Polar or UV (2-axis) format, and to either Polled (requested by host system) or Continuous output. Alternatively, it can be configured in NMEA (0183 Version 3). These are described in Section 9 MESSAGE FORMATS.

WindSonic (option 4) SDI-12 may not be re-configured in any Gill output format and format is SDI-12 (V1.3) and described in Section 14 SDI-12 COMMANDS.

## 3 FAST TRACK SET-UP

If you are in a hurry to try out the WindSonic (options 1, 2 or 3) and are familiar with Gill equipment and coupling to a PC using RS232, go to the following sections:

- Section 7 INSTALLATION
- Section 9 MESSAGE FORMATS
- Section 10 CONFIGURING

After you have successfully set up the WindSonic, we strongly advise that you then go back and read the rest of the manual to ensure that you get the best results from the WindSonic.

## 4 PRINCIPLE OF OPERATION

The WindSonic measures the times taken for an ultrasonic pulse of sound to travel from the North transducer to the South transducer, and compares it with the time for a pulse to travel from S to N transducer. Likewise times are compared between West and East, and E and W transducer.

If, for example, a North wind is blowing, then the time taken for the pulse to travel from N to S will be faster than from S to N, whereas the W to E, and E to W times will be the same. The wind speed and direction can then be calculated from the differences in the times of flight on each axis. This calculation is independent of factors such as temperature.

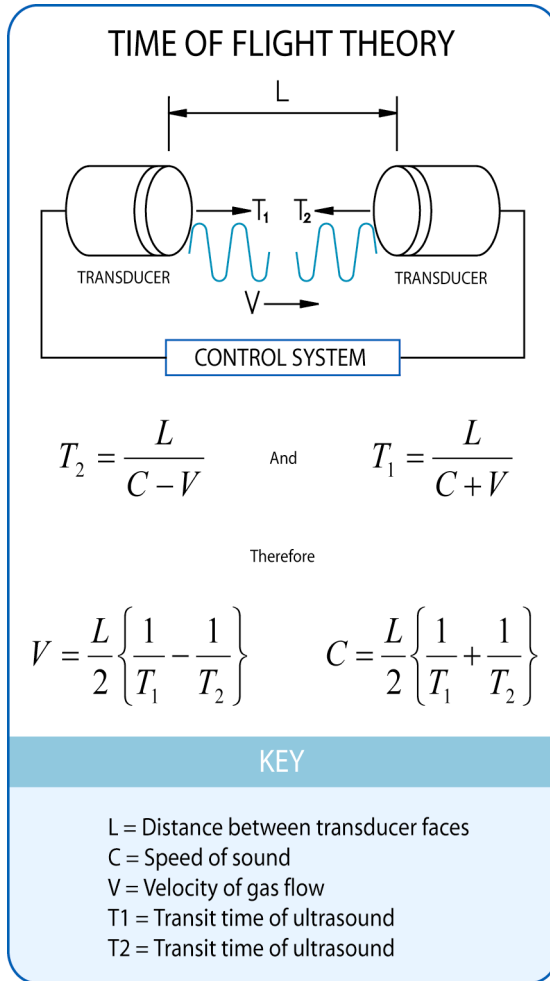

Figure 1 Time of Flight details

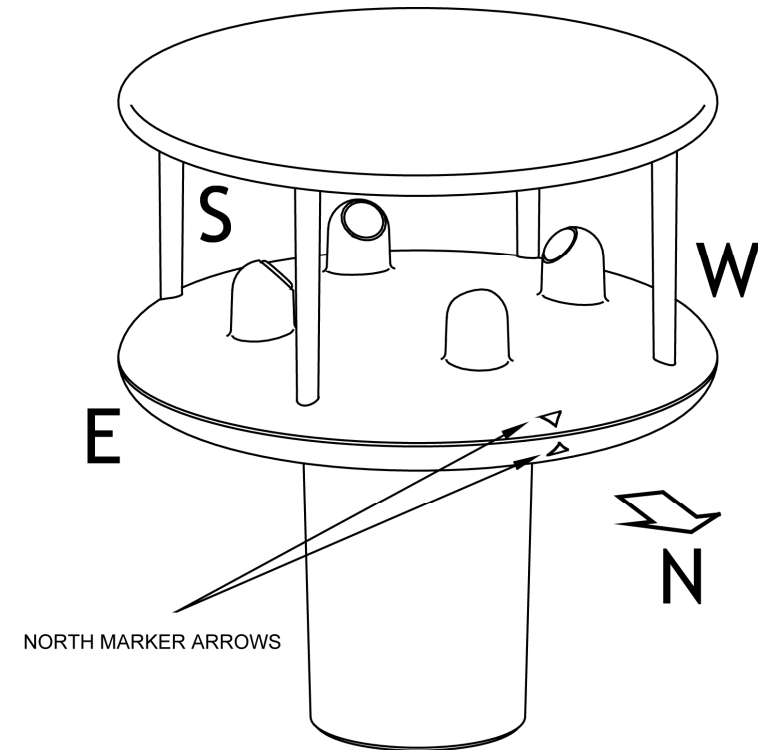

Figure 2 Compass Points

## 5 SPECIFICATION

This Specification relates to WindSonic Option 1, 2 and 3 WindSonic Sensors fitted with a Red Tab and WindSonic 75 Option 1, 2 and 3 fitted with an Orange tab (fitted adjacent to the North Marker arrow).

<b>Output</b>		
Units of measure	Metres/second (m/s), Knots, Miles per hour (mph), Kilometres per hour (kph), Feet per minute (fpm)	
Output frequency	0.25, 0.5, 1, 2, or 4 outputs per second	
Parameters	Digital	Analogue
	Polar - Speed and Direction UV - 2 axis, signed Speed NMEA Speed and Direction Tunnel - U speed & U Polarity	Polar - Speed and Direction UV - U Speed and U Polarity NMEA - Speed and Direction Tunnel - U Speed & U Polarity
<b>Wind Speed</b>		
Range	0 – 60m/s WindSonic 0 - 75m/s WindSonic 75	0 – 5m/s, 0 – 10m/s, 0 – 20m/s, 0 – 30m/s, 0-40m/s, 0 – 50m/s, 0 – 60m/s
Accuracy	± 2% (at 12m/s)	± 2% (at 12m/s)
Resolution	0.01 m/s	10 bits
<b>Wind Direction</b>		
Range	0 - 359°	0 - 359° Or 0 - 539° (Wraparound mode)
Accuracy	± 2° (at 12m/s)	± 2° (at 12m/s)
Resolution	1°	1°
<b>Analogue output formats (not Windsonic 75)</b>		
0-5V 4-20mA 0-20mA	± 1% of full scale N.B. Analogue output impedance = 1K $\Omega$ (V out) Load resistance between the Analogue outputs (Pins 8 & 9) and Signal Ground (Pin 1) must be <= 300 ohms, including cable resistance.	
<b>Digital output formats</b>		
Gill Marine – NMEA	Continuous or Polled (output on request by host system) Polar (Speed and Direction) or UV (2 axis, signed Speed) NMEA 0183 version 3	
<b>Communication formats</b>		
WindSonic Option 1 WindSonic Option 2 WindSonic Option 3 Baud Rate	RS232 RS232, RS422, RS485 (2 wire Point to Point) RS232, RS422, RS485 (2 wire Point to Point), and Analogue 2400, 4800, 9600, 19200, 38400 Baud Rates	
<b>Anemometer status</b>	Status OK and Error codes included in output message	

<b>Environmental</b>	
Moisture protection	IP66
Temperature	Operating -35°C to +70°C Storage -40°C to +80°C
Humidity	Operating <5% to 100%
EMC	EN 61326
<b>Standards</b>	Manufactured within ISO9001: 2008 quality system

<b>Power requirement</b>	5 – 30 V DC Option 1 and 2 units (WindSonic). 7 – 30 V DC. Option 3 units (WindSonic). Current drain depends on variant i.e. RS232 approximately 9mA rising to 44mA for Analogue variant. Lowest power consumption is obtained with the following configuration: - M2, P20, B3, S9 (approximately 5.5mA at 12v).  <b>12 – 30 V DC Option 1, 2 and 3 units (WindSonic 75).</b> Current drain i.e. RS232 approximately 13mA at 12v dc.
<b>Mechanical</b>	
Size / weight	142mm diameter x 163mm 0.5kg
Mounting	Pipe mounting 1.75 inches (44.45mm) diameter
Material	External - Acrylate Styrene Acrylonitrile, Polycarbonate blend.

The Specification for the Option 4 SDI-12 unit is detailed in Section 14.

## 6 PRE-INSTALLATION

### 6.1 Equipment supplied

Item	Quantity
WindSonic	1
Connector and Mounting Screws comprising:-	
9 Way connector	1
Connector Contacts	9
Sealing Gland	1
Sealing Washer	1
Washer shake proof	3
Screws – M5 stainless steel	3
User Manual, Wind and WindView Software on the CD	1

Wind and WindView software is available free of charge from the Gill website –

<http://gillinstruments.com/main/software.html>

#### 6.1.1 WindSonic Part Numbers

1405-PK-021	Black WindSonic Option 1 – RS 232 output only
1405-PK-068	White WindSonic Option 1 – RS 232 output only
1405-PK-038	Black WindSonic Option 2 – RS 232, 422 & 485 (point to point) output
1405-PK-072	White WindSonic Option 2 – RS 232, 422 & 485 (point to point) output
1405-PK-040	Black WindSonic Option 3 – RS 232, 422, 485 p to p & analogue output
1405-PK-073	White WindSonic Option 3 – RS 232, 422, 485 p to p & analogue output
1405-PK-100	Black WindSonic Option 4 – SDI-12 output only
1405-PK-110	White WindSonic Option 4 – SDI-12 output only
1405-PK-400	Black WindSonic 75 Option 1- RS232 output only
1405-PK-420	Black WindSonic 75 Option 2 RS 232, 422 & 485 (point to point) output
1405-PK-423	Black WindSonic 75 Option 3 RS 232, 422 & 485 p to p & analogue op.

Optional extras:

Item	Part No
Cable 4 Pair, twisted and shielded 24 AWG	026-03156
Cable 3 Pair, twisted and shielded 24AWG	026-02660
Cable 15 metres (4 pair twisted and shielded 24AWG – Connector pins attached to one end and stripped wires the other).	1405-10-080
WindSonic connector (1 supplied as standard see above)	1405-PK-069
WindSonic Support Tube 0.5 metre (Aluminium)	1405-30-056
Bracket for mounting to a Pole, includes a WindSonic Adaptor	1771-PK-115

### 6.2 Packaging

Whilst the WindSonic is being moved to its installation site, the unit should be kept in its inner packaging. All the packaging should be retained for use if the unit has to be returned at any time, or if a self-test is performed.

### 6.3 Installation requirements

**Host system** - One of the following:

- PC fitted with a suitable interface to match the chosen communication format (RS232, RS422, or RS485 (point to point), compatible with the WindSonic option selected, and a suitable Terminal Emulation software package. For example HyperTerminal for Windows or Wind Software that is available from the Gill website at <http://gillinstruments.com/main/software.html>.
- Gill WindDisplay (WindSonic option 2 or 3 only).
- Other equipment with input/output compatibility to the WindSonic Option selected.

For example, Data loggers.

**Cable** - To connect between the WindSonic and the host system

*See Section 7.3.1 Cable type for cable specification.*

- There are restrictions on the maximum cable lengths for correct operation.
- The cable should be routed up the inside of the mounting tube.

**Mounting tube (e.g. 0.5 metre long Gill part 1405-30-056)**

- Standard tube 1.75 inches (44.45mm) Outside Diameter x 3mm wall thickness. **Note it is important that the correct diameter tube is used to prevent damage to the WindSonic lower moulding when tightening the screws.**

*See Figure 3, Alignment & Mounting Details on page 26.*

- For non-hostile environments, Aluminium tube can be used.
- For hostile environments, you should select a material suitable for the intended environment. For example, stainless steel 316 for marine use.

**Mounting Bracket (Gill Part 1771-PK-115)**

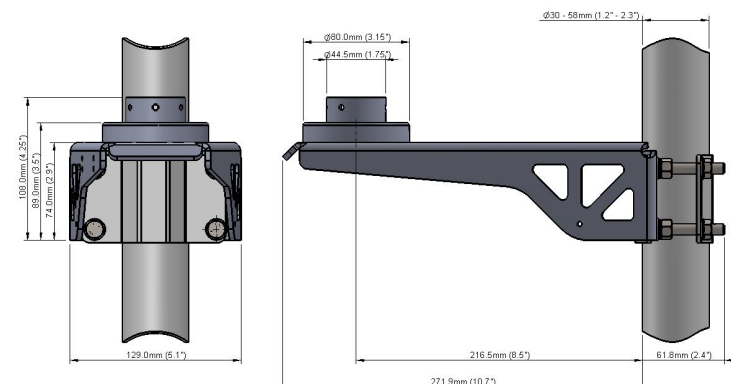

## 6.4 Cable Assembly

Open the pack of parts provided with the WindSonic or as 1405-PK-069

Trim back the screened cable outer and screen sleeves 40mm.

Trim back the screen drain wires flush with the outer sleeve.

Strip back the connection wires by 5mm and tin solder.

Solder the contact pins to the wires (please note that the connector supplies the correct strain relief for cables with an outside diameter of 6-12mm).

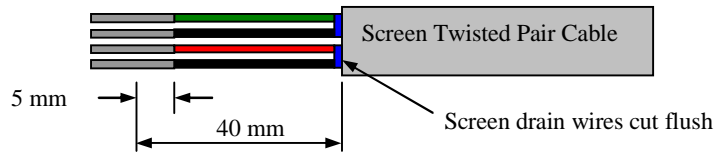

Put the parts on the cable in the order as shown below.



Whilst squeezing the red retainer in the direction of ARROWS A, pull in the direction of ARROW B.



Your connector should now resemble the connector in the picture below.



Insert each contact pin until you feel a slight click. If you have inserted the contact into the incorrect hole it can be removed at this point by simply pulling it out. Please note there will be some resistance.



Rear View of Connector

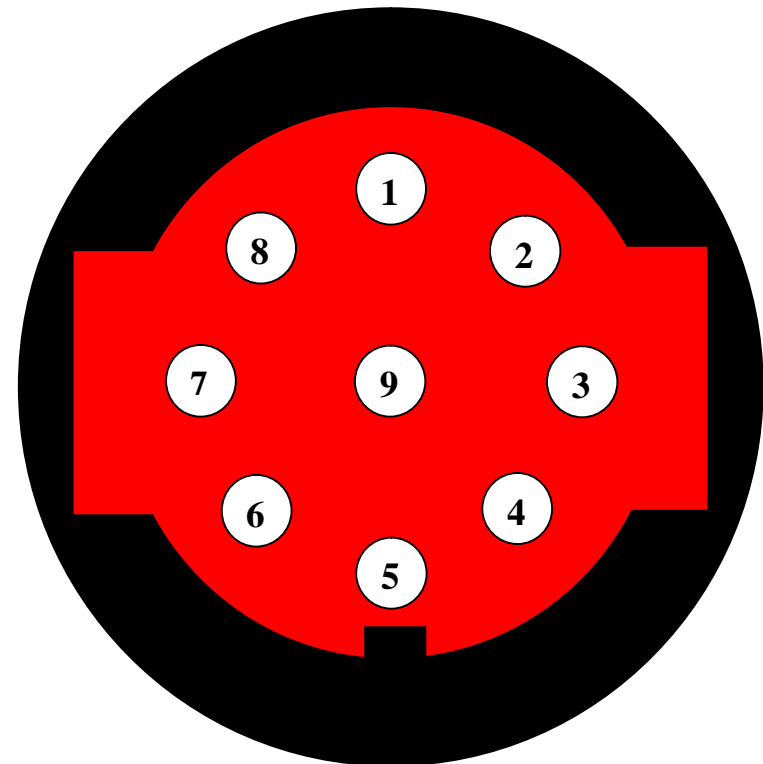

Continue to insert all of the contacts you require. Once all of the contacts are inserted push the red retainer into place. NB. The retainer can only be pushed back into place if the contacts are fully engaged.



Fit the connector to the WindSonic so that you can finish assembling the connector.



Screw the back shell onto the connector until it is fully in place. Please note that the final rotations can be slightly stiff.



Now screw the next part of the connector into place.



Now screw the cable-clamping nut into place.



The connector can now be removed from the WindSonic.

**NOTE: To disassemble the connector, reverse this procedure.**

For spares purposes the complete WindSonic Souriau Clipper connector comprises of:-

9 way Connector	CLF1201.
Connector female contact	CM10SS10MQ.
Sealing Gland Clipper size1	CL101021 (suitable for cables 6-12mm outer diameter).



## 7 INSTALLATION

**Do NOT remove the black “rubber” transducer caps. Warranty is void if the coloured security seal is damaged or removed.**

### 7.1 Installation Guidelines

The WindSonic has been designed to meet and exceed the stringent standards listed in its specification. Operating in diverse environments all over the world, WindSonic requires no calibration and adjustment whatsoever.

As with any sophisticated electronics, good engineering practice should be followed to ensure correct operation.

- Always check the installation to ensure the WindSonic is not affected by other equipment operating locally, which may not conform to current standards, e.g. radio/radar transmitters, boat engines, generators etc.

Guidelines –

- Avoid mounting in the plane of any radar scanner – a vertical separation of at least 2m should be achieved.
- Radio transmitting antennas, the following minimum separations (all round) are suggested
  - VHF IMM – 1m
  - MF/HF – 5m
  - Satcom – 5m (avoid likely lines of sight)
- Use cables recommended by Gill. If cables are cut and re-connected incorrectly (perhaps in a junction box) then EMC performance may be compromised if cable screen integrity is not maintained.
- Earth loops should not be created – wire the system in accordance with the installation guidelines.
- Ensure the power supply operates to the WindSonic specification at all times.

Avoid turbulence caused by surrounding structures that will affect the accuracy of the WindSonic such as trees, masts and buildings. Ideally sensors should be mounted on the prevailing wind side of the site.

The WMO make the following recommendations:

- The standard exposure of wind instruments over level open terrain is 10m above the ground. Open terrain is defined as an area where the distance between the sensor and any obstruction is at least 10 times the height of the obstruction.

If mounting on a building then theoretically the sensor should be mounted at a height of 1.5 times the height of the building.

If the sensor is to be mounted on a mast boom, part way up a tower or mast, then the boom should be at least twice as long as the minimum diameter or diagonal of the tower. The boom should be positioned on the prevailing wind side of the tower.

### 7.2 Bench system test

**Note:** Prior to physically mounting the WindSonic in its final location, we strongly recommend that a bench system test is carried out to confirm the system is configured correctly, is fully functional and electrically compatible with the selected host system and cabling (preferably utilising the final cable length). The required data format, units, output rate, and other options should also all be set up at this stage.

### 7.3 Electrical

#### 7.3.1 Cable

##### Cable type

A RS422 compatible cable should be used, with the number of twisted pairs matching the application.

**Generic description** – Twisted pairs with drain wire, screened with aluminised tape, with an overall PVC sheath of 6mm-12mm outer diameter. Wire size 7/0.2mm (24 AWG).

The table shows some suitable manufacturers’ references; other manufacturers’ equivalents can be used.

Application	No. of pairs	Gill ref. 24 AWG	Belden ref. 24 AWG	Batt electronics ref. 24 AWG
WindDisplay	2	-	9729	-
RS 232	3	026-02660	9730	91030
RS 422	4	026-03156	9728	91199

### Cable length

The maximum cable length is dependent on the chosen communication format (RS232, RS422 or RS485 (point to point), the baud rate, and, to a lesser extent, on the cable type and the local electrical 'noise' level.

The table shows the typical maximum lengths at the given baud rates, using the recommended cable. If any problems of data corruption etc. are experienced, then a slower baud rate should be used. Alternatively, a thicker or higher specification cable can be tried.

WindSonic Option	Communication format	Baud rate	Max. cable length
Option 1, 2 and 3	RS232	9600	6.5 m (20 ft)
Option 2 and 3	RS422 or RS485 point to point	9600	1 km (3200 ft)
Option 3	Analogue – Voltage o/p	N/A	6.5 m (20 ft)
	Analogue – Current o/p	N/A	Resistance dependent (max 300 Ω)

### 7.3.2 Power supply

WindSonic Option 1 and 2 Units; Require a DC supply of between 5V – 30 V DC (30V DC max).

WindSonic Option 3 Units; Require a DC supply of between 7V– 30 V DC (30V DC max).

WindSonic current drain depends on variant i.e. Option 1, RS232 approximately 9mA at 12v dc rising to 44mA for Analogue variant.

Lowest power consumption is obtained with the following configuration: - M2, P20, B3, S9 (approximately 5.5mA at 12v).

**WindSonic 75 Option 1, 2 and 3 Units; Require a DC supply of between 12V – 30 V DC (30V DC max).**

WindSonic 75 Option 1 and 2 current drain is typically approximately 13mA at 12v dc.

### 7.4 Connecting to a PC using RS232 (Option 1 Sensor)

#### Notes

- The cable length for reliable operation is limited to 6.5m (20ft).  
(See Section 7.3.1 Cable length.)
- For longer cable runs, we recommend using the WindSonic configured with RS422 output, and a RS422/232 converter at the PC.
- Wiring connections below are not applicable to WindSonic Options 2 and 3 set for RS232 operation.

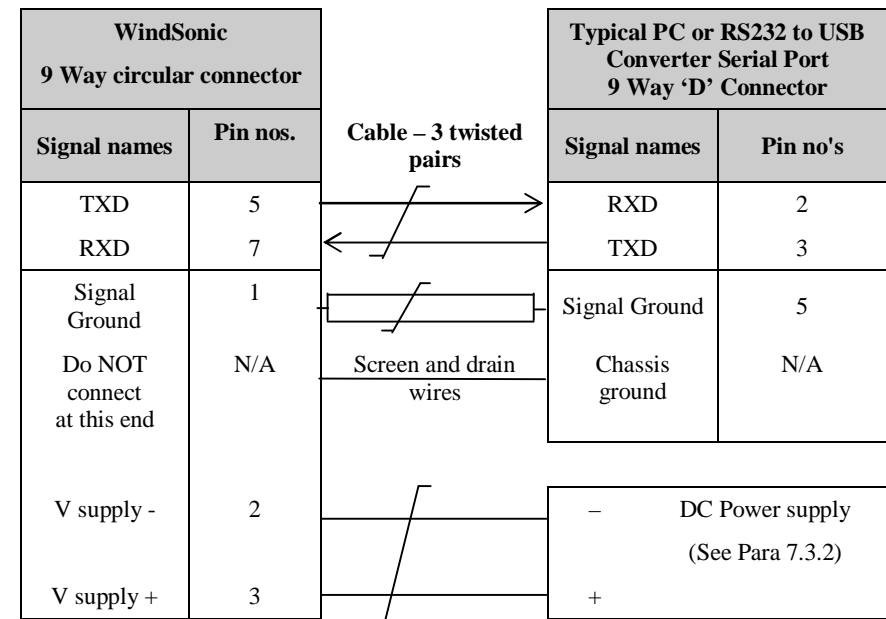

#### Default Settings

The WindSonic Option 1 unit is factory configured with the following default settings:

M2, U1, O1, L1, P1, B3, H1, NQ, F1, E3, T1, S4, C2, G0, K50,

## 7.5 Connecting WindSonic Option 2 or 3 set for default RS422 to a PC using an RS232 Safe Mode Connection.

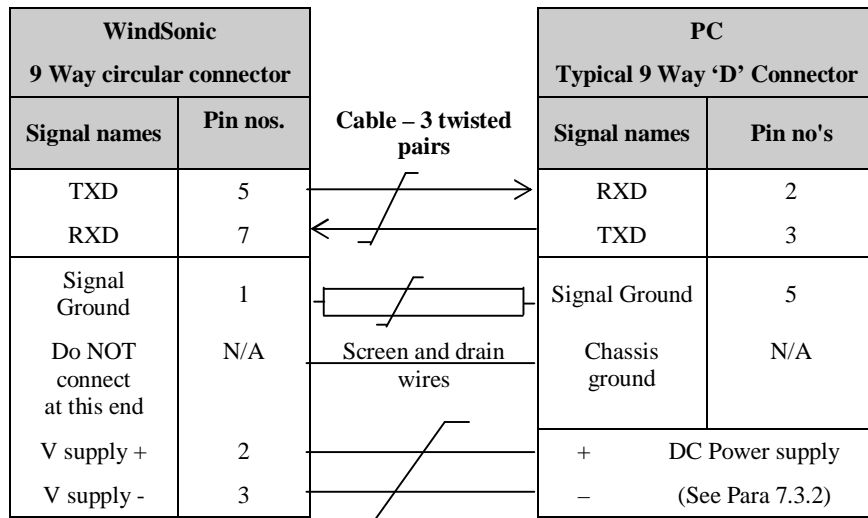

1. Connect the Option 2 or 3 WindSonic as per the above connection diagram.
2. With WindSonic power off, set up a HyperTerminal connection as per Page 46 **but with the Baud rate set to 19200 (this can be at variance with the original WindSonic Baud rate setting).**
3. **Hold down** the \* character (shift 8) and then apply power to the WindSonic. After approximately 3 seconds the unit will respond with **Safe Mode**.
4. To change output communication from RS422 to RS232 then remove any \* characters on screen.
5. Type E3 and press Enter (changes E2 setting to E3).
6. E3 will be seen twice on screen to confirm the setting change to RS232 has occurred.
7. Change any other configuration settings as required.
8. Type Q and press Enter to go back into measurement mode (garbled data may appear on screen if the original WindSonic Baud rate setting is not 19200bauds).
9. If required close the 19200-baud HyperTerminal connection and re-open at the WindSonic Baud rate. If a continuous data mode has been previously chosen then data will scroll on screen.

(Note that supply voltage connections are reversed compared to the Option 1 RS232 unit. Damage will not occur from a reverse voltage connection).

## 7.6 Changing an Option 2 or 3 Sensor set for RS232 back to RS422.

Connect the Option 2 or 3 WindSonic as per Para 7.5.

Repeat instructions shown in Para 7.5 except that in Safe Mode set the E Command to E2 etc.

## 7.7 Connecting to a Gill WindDisplay



Meteorological Display



Marine Display

The WindSonic is designed to interface with the Gill WindDisplay unit to provide a complete wind speed and direction system.

To interface to a non NMEA WindDisplay the WindSonic is set by default for Polar (M2) and 9600 (B3) configuration settings.

When coupled to a WindDisplay, the WindSonic can be used as supplied, however if a fault occurs the WindDisplay may lock into the last valid reading. Re-configuring the WindSonic to Fixed Field output (O2) will ensure that any fault is flagged on the WindDisplay.

After coupling to a WindDisplay, the Wind Speed units and the Averaging period can be selected using the WindDisplay controls. See the WindDisplay User Manual.

Note that although the WindDisplay can display wind speed in various units, these are calculated within the WindDisplay. The data coming to the WindDisplay must be in metres/sec (the factory default output setting).

### Notes

1. WindSonic Option 2 or 3 must be used set for RS422 output (E2 Mode).
2. Use the WindSonic in the factory default mode for the Meteorological Wind Display – i.e. do not reconfigure.
3. **If used with a Marine NMEA 9600 Baud or 4800 Baud WindDisplay set the Wind Sonic for NMEA (e.g. M5) and 9600 Baud (B3) or 4800 Baud (B2).**
4. The WindDisplay can provide power to the WindSonic.

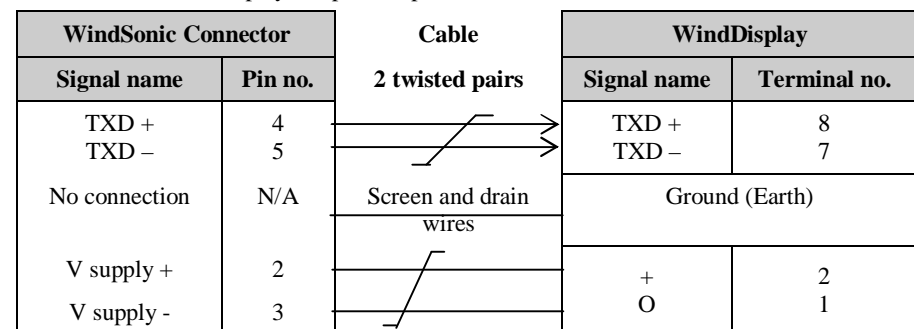

## 7.8 Connecting to a PC using RS422 (Option 2 or 3)

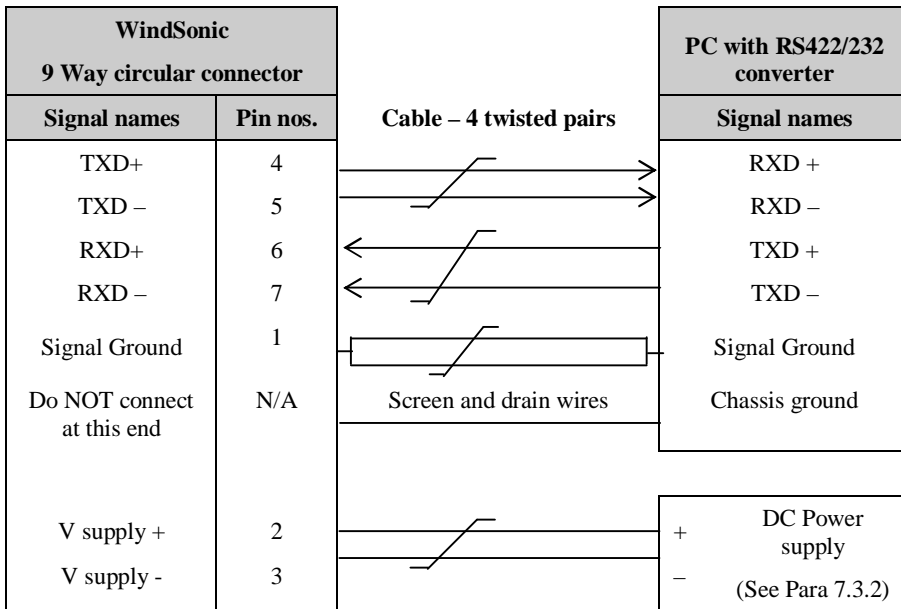

### Notes

WindSonic to be set for RS422/RS485 mode (E2, default).

Analogue Outputs are also simultaneously available from the **Option 3** unit.

### Default Settings

The **WindSonic Option 2 and 3** unit is factory configured with the following default settings:

**M2, U1, O1, L1, P1, B3, H1, NQ, F1, E2, T1, S4, C2, G0, K50**

See Section 10 Configuring for further details

## 7.9 Using RS485 (2 wire point to point) with Option 2 or 3 units

### Notes

- The unit must be set for RS422/485 mode (E2 setting).
- WindSonic must be set in Polled mode**, a node address letter may be given if required.  
*See Section 9.1 WindSonic node address.*
- Customers may poll using terminal software (NOT supplied).
- As unit is point to point only it cannot be networked with other RS485 2 wire devices.

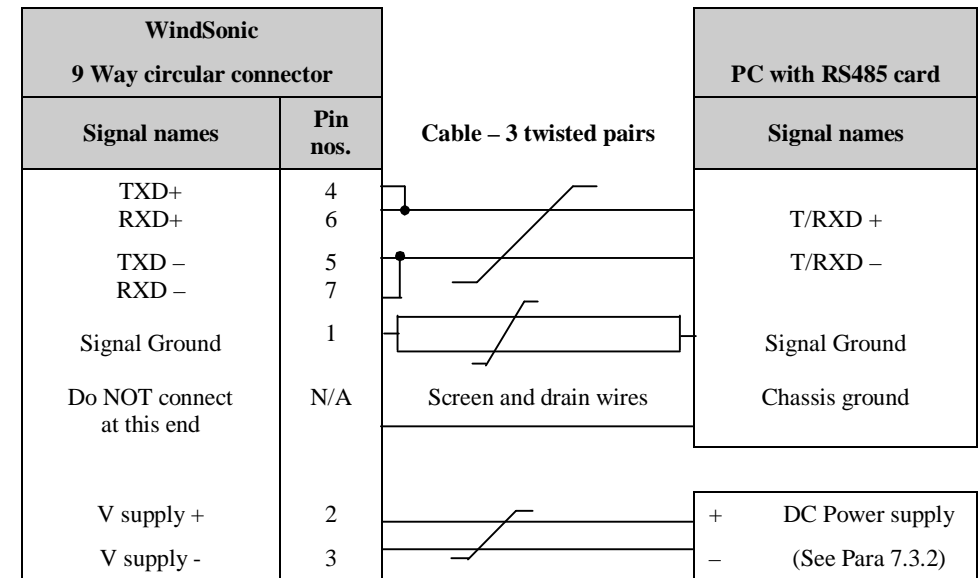

### NOTE:

Analogue Outputs are also simultaneously available from the Option 3 unit.

## 7.10 Using the Analogue Output (Option 3)

### Notes

1. If the Current output is used, the total output load **MUST** be below 300 ohms, including the cable resistance.
2. The current output loads must be returned to Signal Ground.
3. Reconfiguration of the analogue output requires a digital connection (*See sections 9 & 10*).
4. In addition, the digital output can be connected if required using RS232, 422 or 485 point to point, as shown in the previous sections.

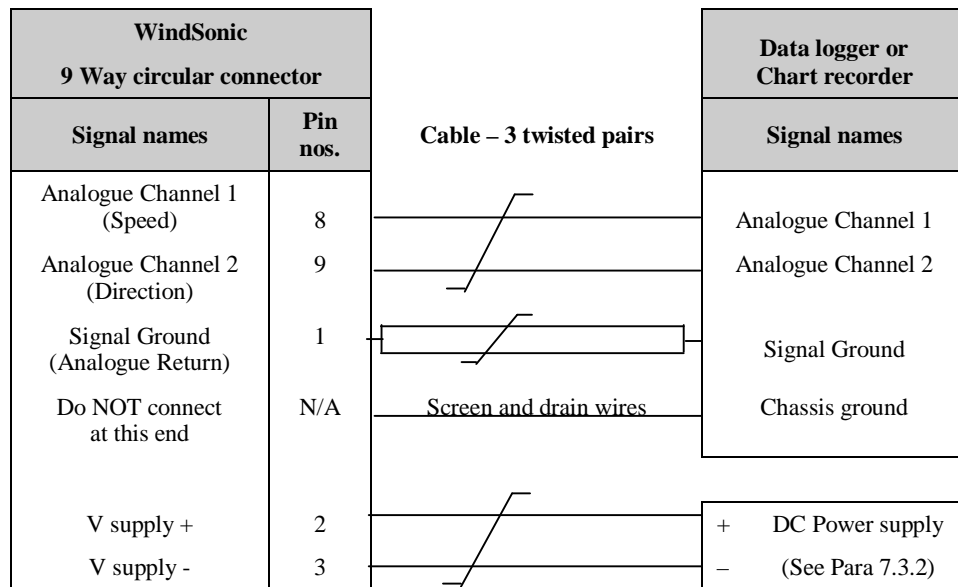

## 8 Mechanical

*Before installing, see note at Section 7.2 Bench system test.*

### 8.1 Orientation

Normally the WindSonic is mounted on a vertical tube, ensuring a horizontal Measuring Plane. *See Figure 3 Alignment & Mounting details*

For indoor use the unit may be mounted with the Measurement Plane set to any required orientation.

#### 8.1.1 Alignment

The WindSonic should be aligned to point to North, or any other reference direction –for example, the bow of a boat.

There are two arrows, a coloured rectangle, and an alignment notch to aid alignment.

*See Figure 3 Alignment & Mounting Details*

**Note:** It is usually simpler to work first with a compass at ground level and identify a suitable landmark and its bearing.

#### 8.1.2 Mounting

**The support tube** requires three 3 equally spaced holes, tapped M5, 7.5mm from the top of the tube. Pass the cable (fitted with the 9 way Clipper plug) through the tube.

**Note:** the customer must fit appropriate strain relief to the cable.

Connect the plug by twisting it whilst pushing it gently into the socket on the WindSonic. When it locates, twist the outer sleeve clockwise to connect and lock the plug.

Fix the WindSonic to the tube using the 3 stainless steel screws provided. (Maximum mounting screw torque 4 Nm.)

It is the responsibility of the customer to ensure that the WindSonic is mounted in a position clear of any structure, which may obstruct the airflow or induce turbulence.

Do NOT mount the WindSonic in close proximity of high-powered radar or radio transmitters. A site survey may be required if there is any doubt about the strength of external electrical noise.

#### The Mounting Bracket (1771-PK-115)

Mount the Sensor on to the bracket mount and if using a Wind Sensor align so that the Sensor North Marker points to the bracket pole.

Secure the sensor to its mount using screws and washers supplied in the Sensor Box.

Torque screws to a maximum of 4 Nm.

The Bracket uses a clamp suitable for attaching to a vertical pipe with a diameter of 30-58mm. When mounting the Bracket Sensor, consider the position, orientation and alignment of the unit. Mount at the top of a Pipe to ensure a clear unobstructed measurement view.

Note that the mounting pipe should first be degreased and when assembling the Bracket clamp assembly the outer clamp nuts need to be tightened evenly to a torque figure of 3 Nm.

The moving plate part of the clamp needs to be reversed for poles below 38 mm diameter.

Screw an Earth cable minimum of 6mm<sup>2</sup> to the Bracket chassis using Screw and Terminal Tag fixings supplied.

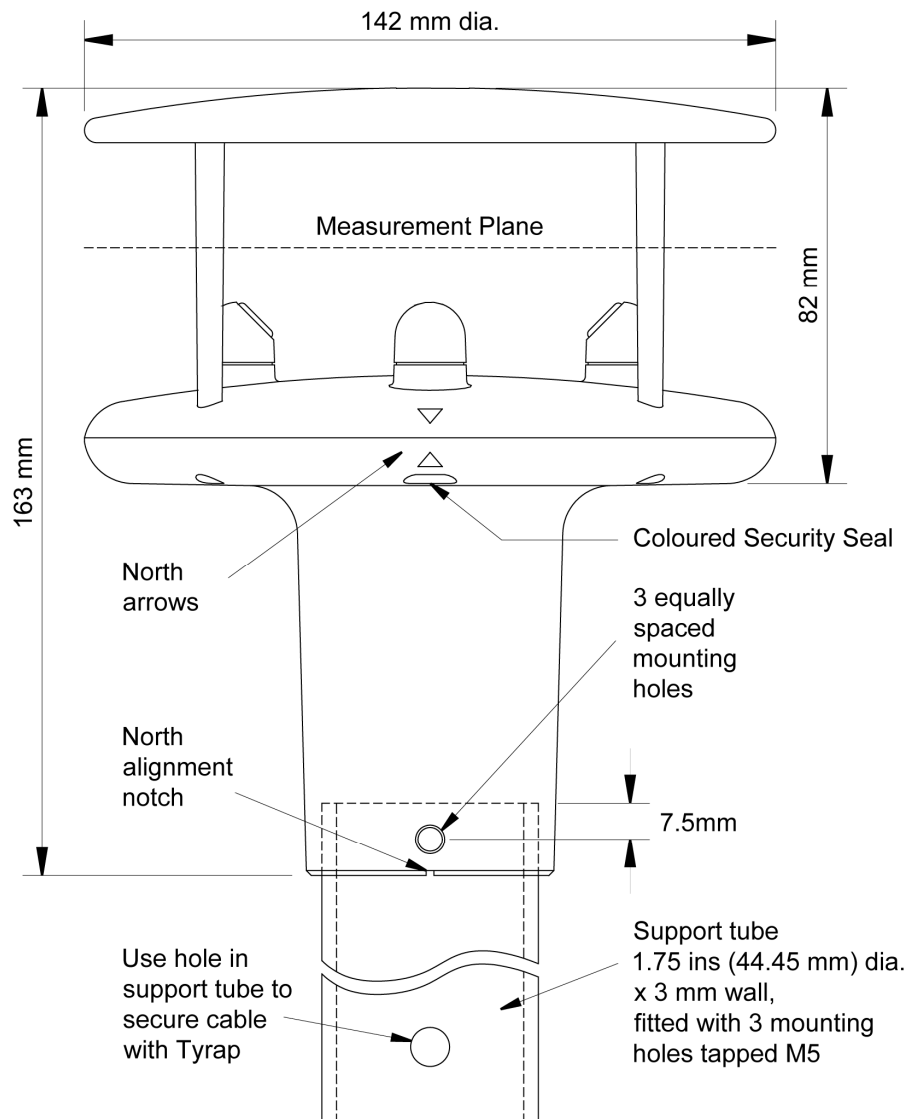

Gill Instruments 0.5 metre Aluminium support tube can be supplied with drilled and tapped M5 holes as above, part number 1405-30-056.

Figure 3 Alignment & Mounting details

## 9 MESSAGE FORMATS

On applying power to the WindSonic, it will provide wind measurements in one of the following formats:

- Gill – Polar, Continuous (**default format**)
- Gill - UV, Continuous
- Gill – Polar Polled
- Gill – UV Polled
- NMEA – IIMWV or WIMWV (with NMEA status Codes)
- NMEA - IIMWV or WIMWV (with Gill Status Codes)
- Tunnel – U Direction, U Speed

Each of these is described below.

Information on how to change the formats and settings follows in Section 10 CONFIGURING.

### 9.1 Gill format– Polar, Continuous (Default format)

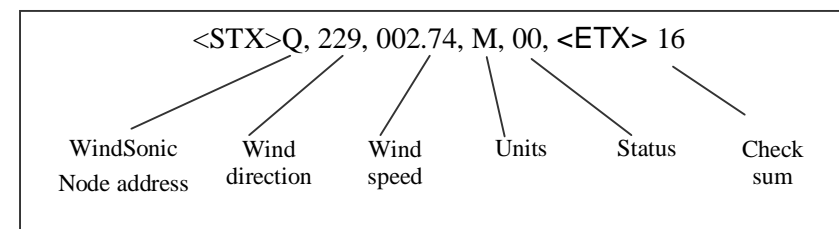

Where:

- |                        |   |   |
|------------------------|---|---|
| <STX>                  | = | Start of string character (ASCII value 2)   |
| WindSonic node address | = | Unit identifier   |
| Wind direction         | = | Wind Direction  |
| Wind speed             | = | Wind Speed  |
| Units                  | = | Units of measure (knots, m/s etc.)  |
| Status                 | = | Anemometer status code ( <i>see Section 11.5 for further details</i> )                              |
| <ETX>                  | = | End of string character (ASCII value 3)   |
| Checksum               | = | This is the EXCLUSIVE – OR of the bytes between (and not including) the <STX> and <ETX> characters. |
| <CR>                   |   | ASCII character   |
| <LF>                   |   | ASCII character   |

### WindSonic node address

The default setting is 'Q'. If required the WindSonic M can be configured to show a different alphabetical node letter (A to Z), so as to identify the WindSonic M.

It is recommended that ID's A to F and K, M, N and P are not used, as these characters can be present in the data string.

### Wind direction

Indicated in degrees, from 0 to 359°, with respect to the WindSonic North marker.

Whilst the wind speed is below 0.05 metres/sec (K50), then in Comma Separated Variable mode no direction value will be output (e.g. Q,,000.03,M,00,1C). In Fixed Field mode wind direction output will freeze at the last known valid direction value (e.g. Q,133,000.02,M,00,1A) until a new valid value can be calculated.

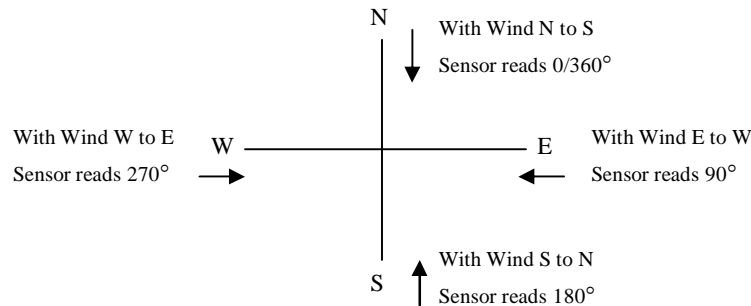

### Wind speed and units

Shows the Wind Speed in the Measurement Plane (*See Figure 3 Alignment & Mounting details*) in one of the following units:

Units	Identifier
Metres per second (default)	M
Knots	N
Miles per hour	P
Kilometres per hour	K
Feet per minute	F

### Low Wind Speeds (below 0.05ms)

Whilst the wind speed is below 0.05 metres/sec, the wind direction will not be calculated. In CSV mode no direction value will be output (e.g. Q,,000.03,M,00,1C). In Fixed Field mode wind direction output will freeze at the last known valid direction value (e.g. Q,133,000.02,M,00,1A) until a new valid value can be calculated.

The above applies with the K command set for K50. If K for instance is set for 100 then the above applies at 0.1m/s.

### Status

This indicates either

Correct operation Code 00 and A (NMEA).

or Error codes *See Section 11.5 for explanation of codes.*

### Checksum

This enables the host system to check that the data has been correctly received. This is the EXCLUSIVE – OR of the bytes between (and not including) the <STX> and <ETX> characters.

### Output rate (not displayed)

The WindSonic samples continuously and delivers wind information at ¼, ½, 1 (default setting), 2, or 4 outputs / second.

## 9.2 Gill format – UV, Continuous

In this mode, the output is given as signed (i.e. positive or negative) speeds along the 'U' (= South – North) axis and the 'V' (= East – West) axis.

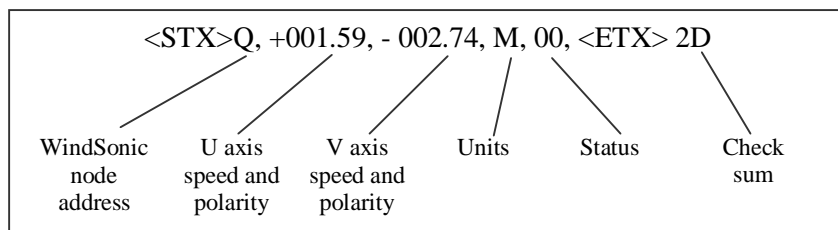

Where:

<STX>	=	Start of string character (ASCII value 2)
WindSonic node address	=	Unit identifier
U axis	=	speed & polarity
V axis	=	speed & polarity
Units	=	Units of measure (knots, m/s etc.)
Status	=	Anemometer status code ( <i>see Section 11.5 for further details</i> )
<ETX>	=	End of string character (ASCII value 3)
Checksum	=	This is the EXCLUSIVE – OR of the bytes between (and not including) the <STX> and <ETX> characters

The WindSonic unit identifier, Units, and Checksum are as described in Section 0 above. Figure 5 shows the polarity of U and V if the wind components along the U and V axis are blowing in the direction of the respective arrows.

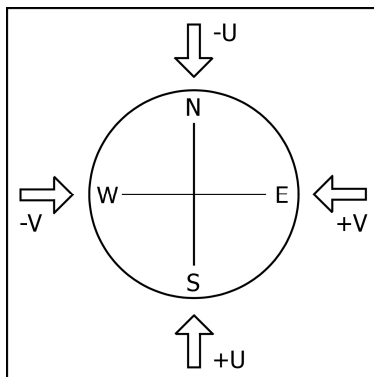

Figure 5 UV Polarity

## 9.3 Gill format – Polled (Polar or UV)

When in the Polled mode, an output is only generated when the host system sends a Poll signal to the WindSonic consisting of the WindSonic Unit Identifier – that is, the relevant letter A – Z.

The output formats are otherwise as described in Sections 9.1 and 9.2.

The commands available in this mode are:

Description	Command	WindSonic response
WindSonic Unit Identifier	A ..... Z	Wind speed output generated
Enable Polled mode	?	(None)
Disable Polled mode	!	(None)
Request WindSonic Unit Identifier	? &	A ..... Z (as configured)
Enter Configuration mode	*<N>	CONFIGURATION MODE

Where <N> is the unit identifier, it is recommended that ID's A to F and KMNP are not used as these characters can be present in the data string.

Notes: -

It is suggested that in polled mode the following sequence is used for every poll for information.

? Ensures that the Sensor is enabled to cover the event that a power down has occurred.

A-Z Appropriate unit designator sent to retrieve a line of data.

! Sent to disable poll mode and reduce possibility of erroneous poll generation.

When in polled mode the system will respond to the data command within 130mS with the last valid data sample as calculated by the Output rate (P Mode Setting).

If the unit is powered down after use or upon switch on then allow 5 seconds from switch on before sending poll commands.

Polled mode can only be used for point to point communications. It is not possible to network units on a common bus.



## 9.4 NMEA Format (NMEA status Codes)

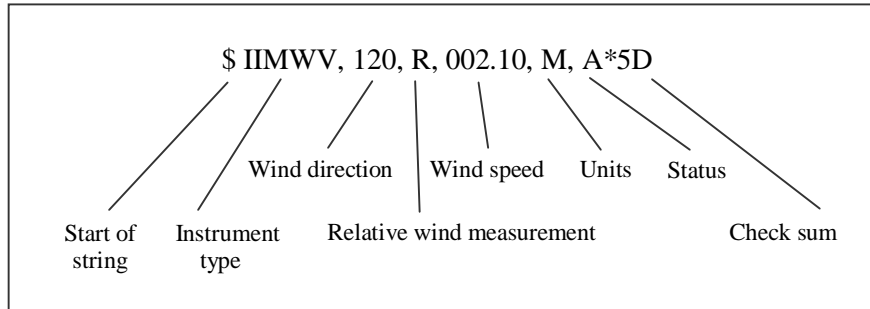

The **Wind Direction**, **Wind Speed**, and **Units** are as described in Section 9.1.

The **Instrument Type** – IIMWV - is a mnemonic for Integrated Instrument Mean Wind direction & Velocity.

The **Status** codes are:

- A Acceptable measurement
- V Void measurement

A typical WindSonic configuration suitable for NMEA (See Section 10):

M5, U1, O1, L1, P1, B2, H1, NQ, F1, E2, T1, S4, C2, G0, K50

Consult specification NMEA 0183 version 3 (available on the web) for complete interface details.

The WindSonic can also be set for the alternative start of string NMEA format WIMWV (Mode 14, which is a Mnemonic for: -

Wind Instrument Mean Wind direction and Velocity.

The string format will appear as above but with WIMWV at the start of the string.

## 9.5 NMEA Format (Gill status Codes)

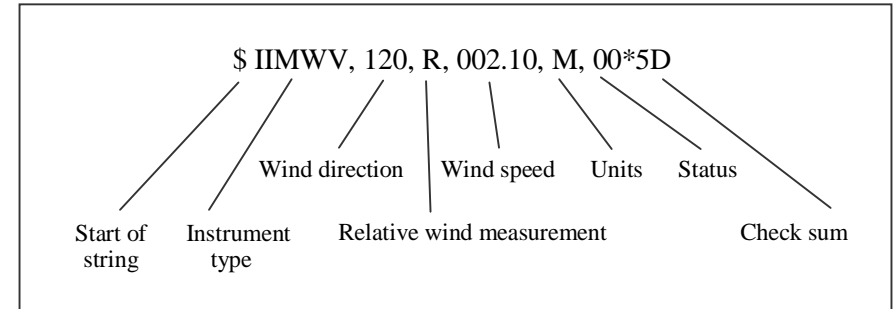

The **Wind Direction**, **Wind Speed**, and **Units** are as described in Section 9.1.

The **Instrument Type** – IIMWV - is a mnemonic for Integrated Instrument Mean Wind direction & Velocity (alternative start of string format WIMWV can be selected).

The **Gill Status** codes are as described in Para 11.5.

A typical WindSonic configuration suitable for NMEA (See Section 10):

M16, U1, O1, L1, P1, B3, H1, NQ, F1, E2, T1, S4, C2, G0, K50

Consult specification NMEA 0183 version 3 (available on the web) for complete interface details.

## 9.6 Gill format – Tunnel Mode (UU, Continuous)

In this mode, the output is given as a signed figure (i.e. positive or negative) along the 'U' (= South – North) axis.

Direction is indicated by a 0 or 1.

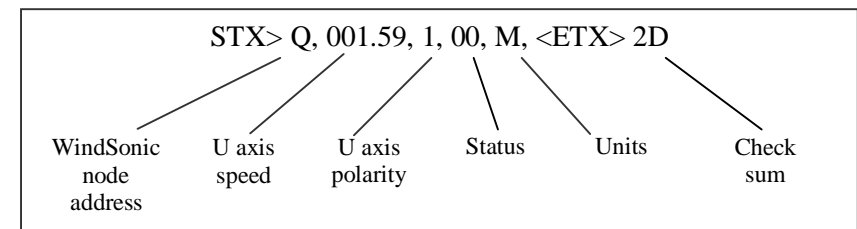

Where:

- <STX> = Start of string character (ASCII value 2)
- WindSonic node address = Unit identifier
- U axis = U axis Wind Speed
- U axis = U axis Wind Direction Polarity where: -  
0 (-U vector) is a wind from the North direction or  
1 (+U vector) is a wind from the South direction.

See Section 9.1 for other string information.

## 9.7 Analogue Outputs and Options

**Notes:** Analogue outputs are only available from WindSonic Option 3.

Analogue Wind Speed output is in Metres/Second only.

### 9.7.1 Voltage or Current output

The WindSonic (Option 3) can be configured for either Voltage (0 – 5 V) or Current (0 – 20mA and 4 – 20 mA) outputs.

**Important:**

- When using the current outputs, the load resistance between the Analogue outputs (Pins 8 & 9) and Signal Ground (Pin 1) must be  $\leq 300$  ohms, including cable resistance.  
*This is to ensure that the voltage levels on Pins 8 & 9 do not exceed 5V.*
- The current outputs must be returned to Signal Ground (Pin 1).

### 9.7.2 Analogue Output Modes

Analogue Outputs	Polar Mode Modes 2 and 4	NMEA Mode Modes 5,14,15 & 16	UV Mode Modes 1 and 3	Tunnel Mode Mode 12
Channel 1 (Pin 8 wrt Pin 1)	Wind Speed	Wind Speed	U Wind Speed	U Wind Speed
Channel 2 (Pin 9 wrt Pin 1)	Wind Direction	Wind Direction	U Wind Polarity	U Wind Polarity

### 9.7.3 Polar mode direction wraparound

The Wind Direction in Polar mode can be configured for either Standard (0 - 359°) or Wraparound (0 - 539°) options. If the Standard mode is used with a chart recorder, large swings of the recorder pen will be experienced each time the wind direction passes between 0 and 359°. Using the Wraparound mode, when the wind first changes from 0° to 359°, there will be a step change on the output, but after this first time the output will change smoothly each time the wind passes through 360°. (Similarly, the first time the wind veers from 539° to 180°; there will be a step change, after which the output will change smoothly).

Wind Direction (degrees)	Voltage Output (0v to 5V)		Current Output (0mA to 20mA)		Current Output (4mA to 20mA)	
	Standard	Wraparound	Standard	Wraparound	Standard	Wraparound
0	0	0	0.00	0.00	4.00	4.00
180	2.5	1.67	10.00	6.67	12.00	9.33
360	5.0	3.33	20.00	13.33	20.00	14.67
540	N/a	5.0	N/a	20.00	N/a	20.00

### 9.7.4 Wind Speed scaling

Analogue Outputs are always scaled in m/s irrespective of the digital output units of measurement setting.

The Wind Speed output can be configured such that full-scale output represents 5, 10, 20, 30, 40, 50 or 60 metres/sec.

In all cases zero Wind Speed is represented by 0V, 0mA or 4mA.

### 9.7.5 Tunnel mode

When configured in Tunnel mode, Channel 1 output represents the wind speed along the U axis (South – North) scaled as described above.

Channel 2 gives the direction of the wind along the U axis, where a –U vector (= wind from the N direction) is represented by 0V (or 0mA, 4mA), and a +U vector is represented by 5V (or 20mA).

### 9.7.6 Analogue Output Rate

In Continuous and Polled modes the analogue output update rate will be determined by the P command setting.

### 9.7.7 Disabled outputs

If the analogue outputs are not required, they can be disabled (Command S9).

### 9.7.8 Analogue Output Conditions

Analogue signals are output together with Digital Outputs signals.

Analogue signals are output continuously when in Digital Polled Mode.

Note: - The WindSonic provides the power for current output loads. Do not connect the WindSonic output to instruments where power for the current loop is provided by the instrument connecting to the WindSonic current output connections.

### 9.7.9 Low wind speeds (below 0.05 m/s).

Whilst the wind speed is below 0.05 metres/sec, the wind direction will not be calculated. In both CSV mode and in Fixed Field mode, Channel 2 wind direction output will freeze at the last known valid direction value until a new valid value can be calculated.

The above applies with the K command set for K50. If K for instance is set for 100 then the above applies at 0.1m/s.

Wind Speed Condition	Channel 1 Speed Output	Channel 2 Direction Output
Greater Than 0.05m/s	0-5v, 0/4 – 20mA variable	0-5v, 0/4 – 20mA variable
Less Than 0.05m/s	0-5v, 0/4 – 20mA variable	Hold last known good reading above 0.05m/s speed until wind speed increases above 0.05m/s

### 9.7.10 Error condition reporting

In both CSV and Fixed Field Modes, if a valid wind measurement cannot be calculated due to a fault condition (for example all paths blocked), the Analogue outputs on Channels 1 and 2 can report a digital error status condition depending on the Y command setting.

**NOTE: The Y command is not applicable to WindSonic 75 Analogue output units. WindSonic 75 units will report Error conditions as though set for Y1 below.**

#### Y1 setting (Default).

Under data error conditions will switch back and forth between 0 and 5V (or 0/4 to 20mA) at the selected output rate.

The following table summarises the above reporting conditions with Analogue Outputs set for Polar Continuous Output and 0-5v (T1), 0-20mA (T5) and 4-20mA (T3).

Wind Speed Condition	Channel 1 Speed	Channel 2 Direction
Digital Error Code Output e.g. 01, 02, 04 etc.	Cycle 0 – 5 – 0 v at output rate	Cycle 0 – 5 – 0 v at output rate
	Cycle 0 – 20 – 0 mA at output rate	Cycle 0 – 20 – 0 mA at output rate
	Cycle 4 – 20 – 4 mA at output rate	Cycle 4 – 20 – 4 mA at output rate

### Y2 nnn Setting, User Set Fixed Analogue Output level in an error mode.

The unit will output a fixed Voltage (T1 setting) or fixed milli-amp (T5/T3 settings) signal on the analogue output with a value depending on the Y2 nnn setting.

nnn is user-selectable value between 000 to 200.

Scale factor for fixed voltage output is 0.025V.

Scale factor for fixed current output is 0.1mA.

Therefore:-

nnn value = Required fixed Error Voltage/0.025 (voltage output setting T1).

nnn value = Required fixed Error Current/0.1 (current output settings T5/T3).

Under data error conditions then by setting the unit for Y2 configuration the analogue outputs will read a user set error value for the period of the error condition as follows with the unit in Polar Continuous Output and 0-5v (T1), 0-20mA (T5) and 4-20mA (T3).

Wind Speed Condition	Channel 1 Speed	Channel 2 Direction
Digital Error Code Output e.g. 01, 02, 04 etc	Error Condition nnn x 0.025 v (T1 setting).	Error Condition nnn x 0.025 v (T1 setting).
	Error Condition nnn x 0.1mA. (T5 & T3 setting)	Error Condition nnn x 0.1mA. (T5 & T3 setting)

### Y3 nnn setting Analogue Output cycles to a user determined level in an error mode.

Under data error conditions the analogue outputs will switch back and forth between a user determined level (voltage or current) with a value depending on the Y3 nnn setting.

nnn is user-selectable value between 000 to 200.

Scale factor for upper voltage output is 0.025V.

Scale factor for fixed current output is 0.1mA.

Therefore:-

nnn value = Required Error Voltage/0.025 (voltage output setting T1).

nnn value = Required Error Current/0.1 (current output settings T5/T3).

The following table summarises the above reporting conditions with Analogue Outputs set for Polar Continuous Output and 0-5v (T1), 0-20mA (T5) and 4-20mA (T3).

Wind Speed Condition	Channel 1 Speed	Channel 2 Direction
Digital Error Code Output e.g. 01, 02, 04 etc.	Cycle 0 – set v – 0 v at output rate	Cycle 0 – set v – 0 v at output rate
	Cycle 0 – set mA – 0 mA at output rate	Cycle 0 – set mA – 0 mA at output rate
	Cycle 4 – set mA – 4 mA at output rate	Cycle 4 – set mA – 4 mA at output rate

**ERROR CONDITION REPORTING NOTES:**

1. Y1, Y2 and Y3 settings are implemented in firmware version 2368-110-01 and onwards.
2. The Y command is not reported in the D3 string, a Terminal Program is used to set up the Y Command.
3. When setting Y2 or Y3 level note that there is a space character after Y2 or Y3 and before the nnn value e.g. Y2 150.

For instance if the unit is set for 0-5v analogue outputs and it is required to report a fixed voltage level of 3.75v under error conditions (Y2 150) then:-

Open a terminal program (e.g. HyperTerminal, Tera Term or Gill Wind Software (Wind Wizard not applicable)) at the matching COM Port connection and Baud rate.

Type \* to place the unit into CONFIGURATION MODE.

Type Y2 150 and press the Enter key.

Type Q and press Enter to return to Measurement Mode.

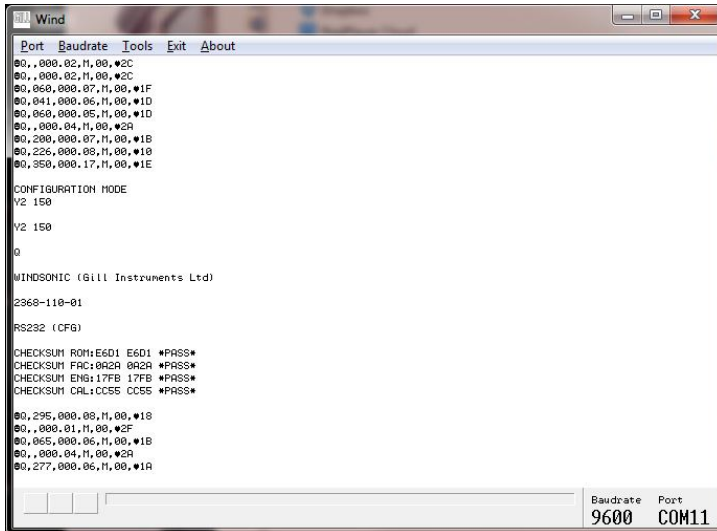

4. To check the Y settings then in Configuration Mode Type Y and press the Enter key and the unit will report Y1 or the full Y2 or Y3 setting e.g.

Y

Y2 0 (=Y2 000)

Y

Y2 1 (=Y2 001)

Y

Y2 10 (=Y2 010)

Y

Y2 100 (=Y2 100)

**10 CONFIGURING**

Gill Wind Software may be used to configure the WindSonic; alternatively, the user may elect to use another terminal emulator package such as Windows HyperTerminal. This section describes the commands used to change User and Communications settings.

**10.1 Wind**

Wind software is available on the supplied CD or to download, free of charge, from the Gill Instruments Limited website <http://gillinstruments.com/main/software.html>.

Wind software allows the unit configuration to be changed and to be able to display the Digital Data String on a PC screen.

**NOTE: Wind is not compatible with WindSonic Option 4 – SDI-12 or WindSonic units prior to serial number 08100001 with a yellow or blue tab adjacent to the North Marker.**

Connect both WindSonic transmit and receive data lines to the PC to establish 2 way communications.

Open Wind Software and select the appropriate Com Port from the drop down menu and click on OK to reach the data screen.



If data is not correctly displayed then on the Menu click on Tools/Synch Comms.

The Sensor will be interrogated and Sensor Baud Rate and Mode settings detected and reported.

Wind software settings will be adjusted to match those of the sensor to show data scrolling on screen.

If after Synch Comms there is still a problem, repeat Synch Comms or switch off the sensor and switch back on again and repeat above procedure.

**Note: - It is also possible to use Wind as a Terminal Program and change settings using the Configuration Mode of operation (Commands are listed in Para's 10.4 to 10.7.1).**

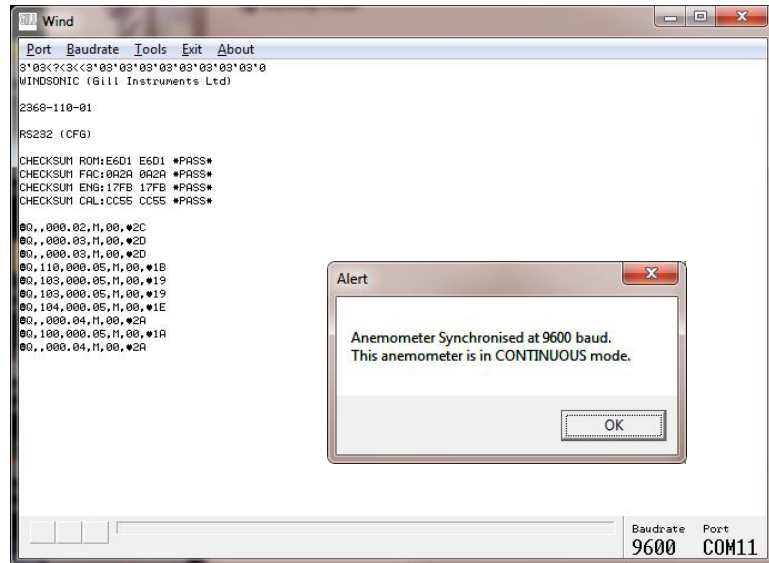

If you wish to review the Sensor Settings click on **Tools/Report Config.**

When selected a similar message to that below will be seen.

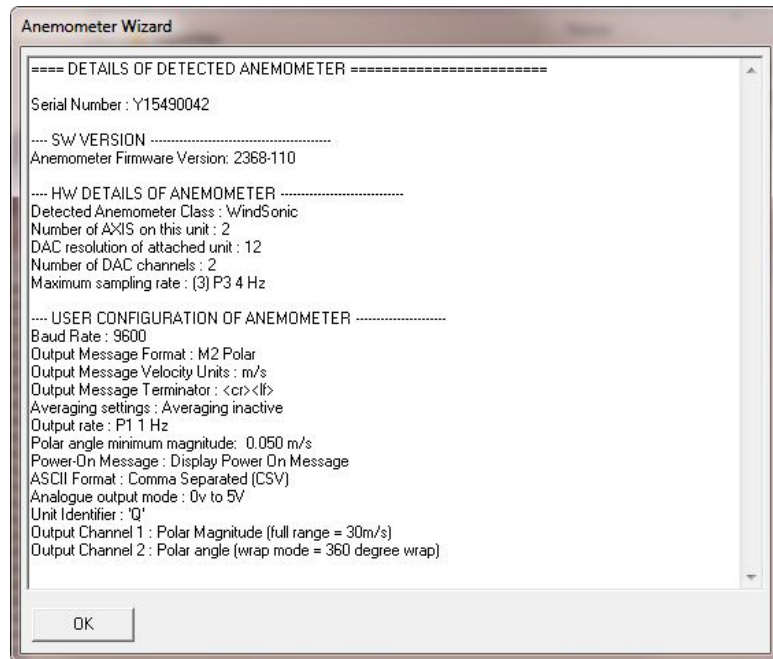

To review and change the WindSonic configuration click on **Tools/Wizard**

Typical Screen is shown following:-

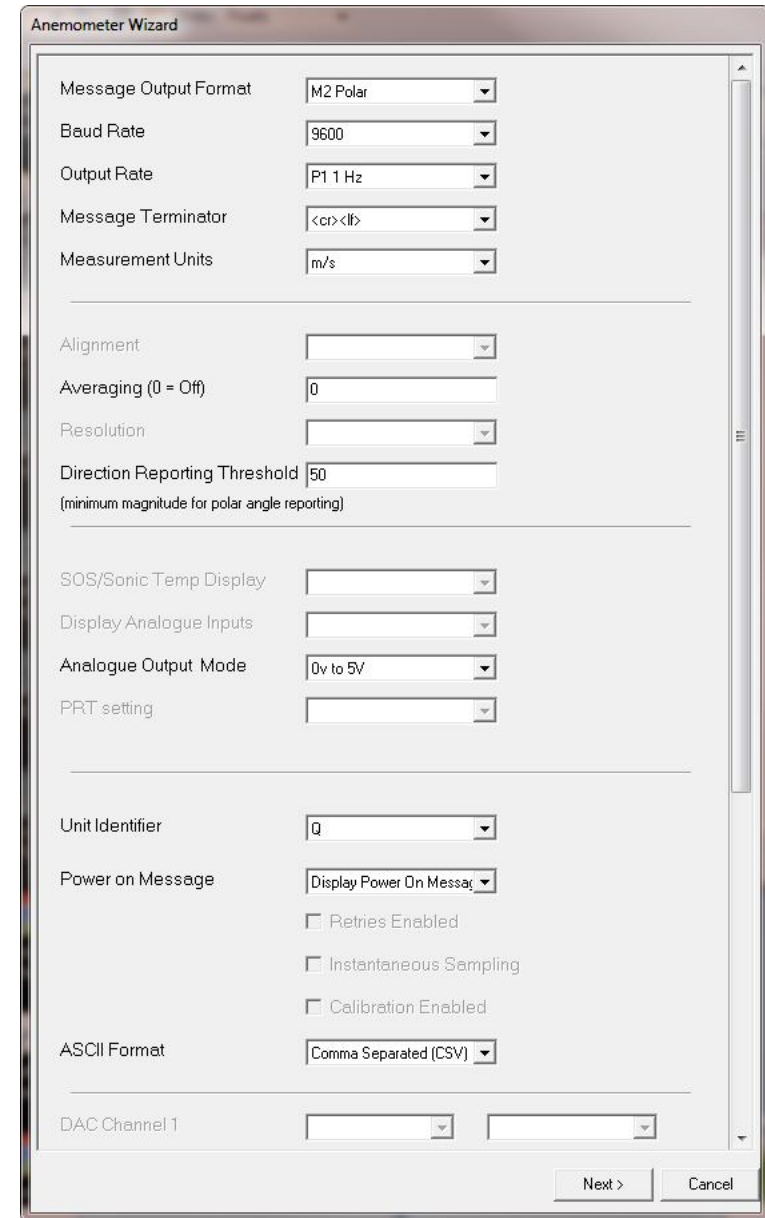

To change a setting i.e. change from M2 (Polar) to M1 (UV), select M1 from the Wizard drop down list then click on Next.

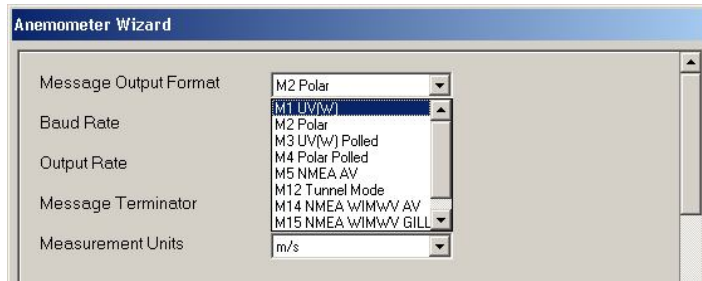

The following screen will show settings that will be changed. Then click on Next.

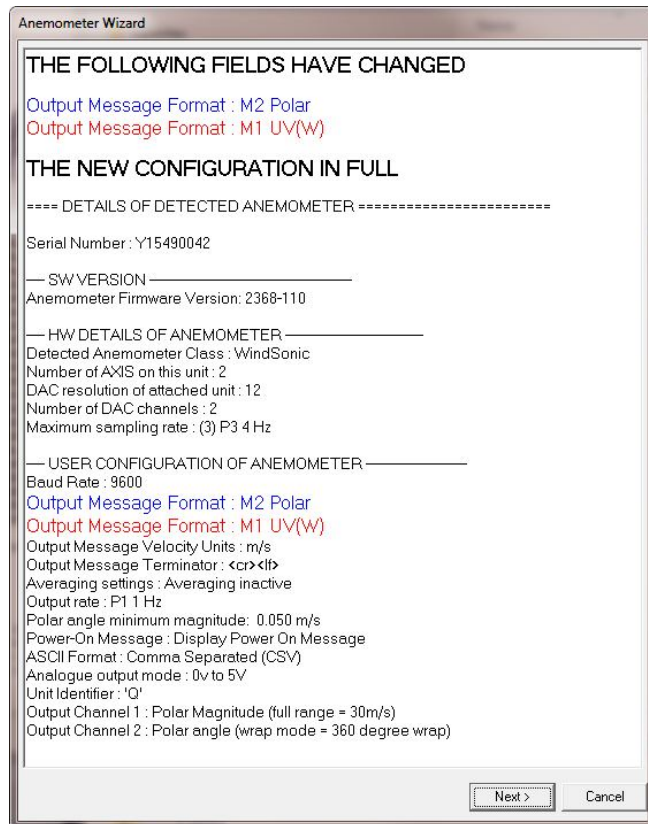

Wind will report Setting Up Anemometer and then re-start the anemometer scrolling data in UV mode.

**Note:** - It is also possible to change settings in Wind using the Configuration Mode operation and using Commands listed in Para's 10.4 to 10.7.1.

## 10.2 WindView

Gill WindView software is available on the supplied CD or as a download, free of charge from the Gill Instruments Limited website <http://gillinstruments.com/main/software.html>

WindView features include: -

- Data Display
- Data Logging

### NOTES:

*WindView cannot be used to change the WindSonic configuration.*

*WindView is not compatible with WindSonic Option 4 – SDI-12 or WindSonic units prior to serial number 08100001 with a yellow or blue tab adjacent to the North Marker.*

Open Gill WindView software program.

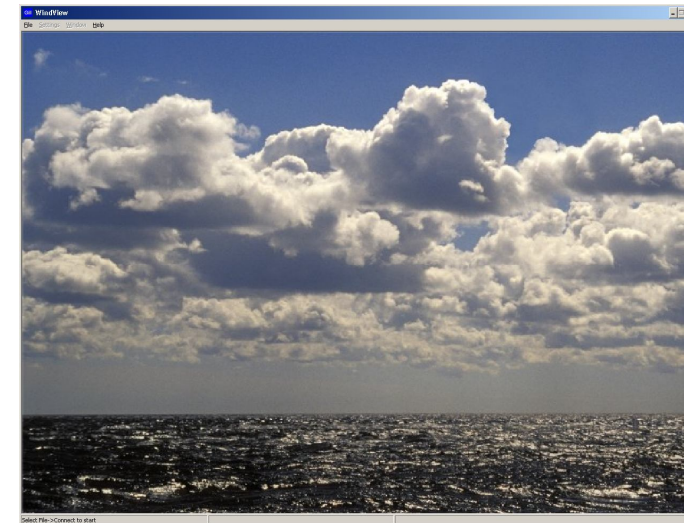

Select File/Connect as follows:-



Select the required COM Port from the drop down list.

Select the required Baud rate from the drop down list.

Parity should be set to None.

If the Baud rate setting of the Anemometer is unknown then the Auto Find button can be used to interrogate the Anemometer and detect the required setting.

Click on the Connect button.

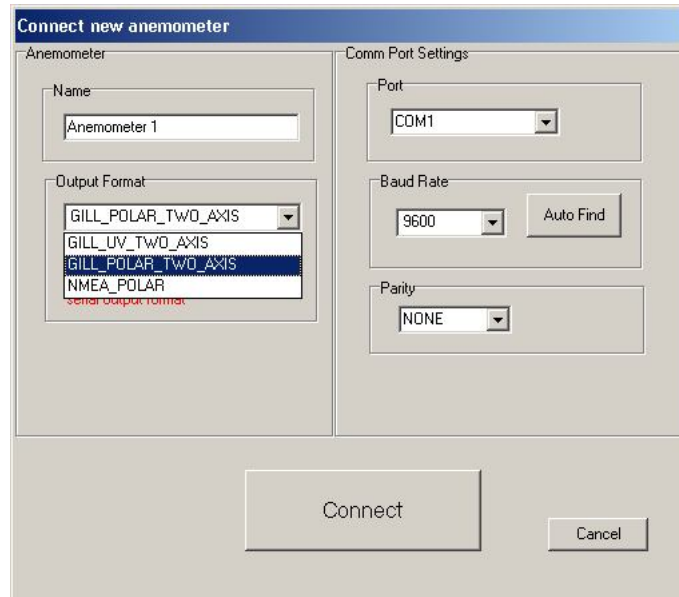

Data should scroll on the screen as follows (Data button).

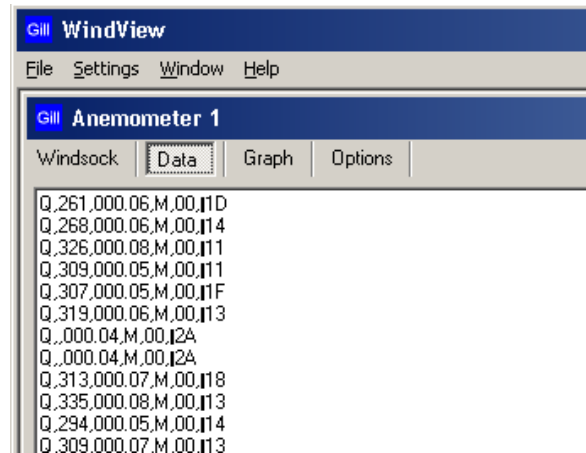

Clicking on the Anemometer 1 Windsoc button gives the following display.

To Change WindView Display Settings

Click on the top of Screen menu Settings.

To change displayed units select and click on required measurement units. If for instance the sensor data was outputting metres per second data then WindView performs the calculation to convert and display the output in knots/mph/kph etc.

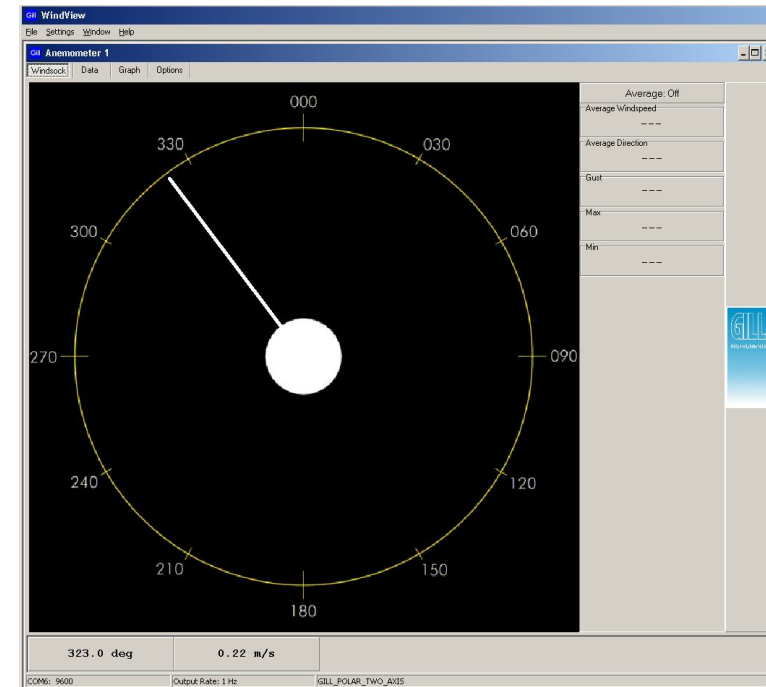

For Logging Facilities.

Click on Settings/Logging to reach the logging screen.

If segmented logging is required this will create and save individual files of length set by the figure in the mins box. Otherwise a continuous log file will be recorded.

Select required Directory for saved file and File name.

Click on Apply.

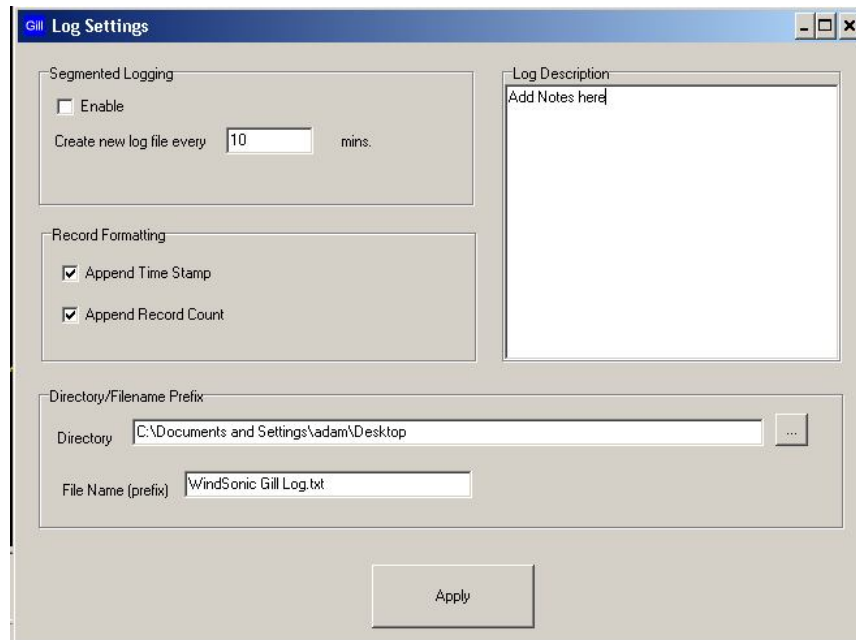

Click on the Note OK button.



To Start Logging select File/Log/Start.



To Stop logging select File/Log/Stop.

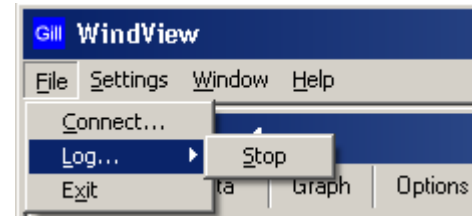

Example saved data opened in Notepad.

```

File Edit Format View Help
WindView Log File
Add Notes here
WindSonic log test
Name: Anemometer 1
Output Format: GILL_POLAR_TWO_AXIS
Log file opened: 13/06/2008 10:50:09

Q,322,000.22,M,00,01D,1,13/06/2008 10:50:10
Q,307,000.22,M,00,01A,2,13/06/2008 10:50:11
Q,342,000.28,M,00,011,3,13/06/2008 10:50:12
Q,320,000.29,M,00,014,4,13/06/2008 10:50:13
Q,340,000.12,M,00,01A,5,13/06/2008 10:50:14
Q,312,000.21,M,00,01D,6,13/06/2008 10:50:15
Q,318,000.37,M,00,01D,7,13/06/2008 10:50:16
Q,321,000.26,M,00,01A,8,13/06/2008 10:50:17
Q,291,000.19,M,00,01C,9,13/06/2008 10:50:18
Q,312,000.14,M,00,01B,10,13/06/2008 10:50:19
Q,314,000.20,M,00,01A,11,13/06/2008 10:50:20

```



## 10.3 Configuring using HyperTerminal

**Note** – Other terminal emulators are configured in a very similar way.

1. Determine the COM port the WindSonic is connected to.
2. Run Hypertrm.exe.
3. Create a New Connection (File → New Connection)
4. Enter a **Name** (eg WindSonic 1).
5. Change '**Connect Using**' to 'Direct to Com 1' (or other Com port as required)
6. Adjust the Port settings to match WindSonic settings. WindSonic default settings are :

**Bits per second** 9600

**Data bits** 8

**Parity** None

**Stop bits** 1

**Flow Control** (Handshaking) None

Click on OK and data similar to the following example will scroll on screen at the output rate:

☺ Q, 229, 002.74, M, 00, ♥ 06

## 10.4 Entering Configuration mode

**From Continuous mode**

Type **\***

**From Polled mode**

Type **\*** then **<N>**

Where <N> is the Unit identifier

The WindSonic responds with a CONFIGURATION MODE message, stops reporting wind measurements, and waits for a command (as detailed below).

## 10.5 Returning to Measurement mode

Type **Q** then press **ENTER**

The WindSonic responds with a checksum test and then continuous wind information when in continuous mode, or on receipt of a Poll signal when in Polled mode.

## 10.6 Checking the configuration

We recommend that, as a standard procedure, you use this command prior to, and after, changing any settings. It shows the current settings for all the alterable settings.

Type **\***

Type **D** **3** then press **ENTER**

The WindSonic responds with the default settings shown below for **Option 1 units**.

**M2, U1, O1, L1, P1, B3, H1, NQ, F1, E3, T1, S4, C2, G0, K50**

The WindSonic responds with the default settings shown below for **Option 2 and 3 units**.

**M2, U1, O1, L1, P1, B3, H1, NQ, F1, E2, T1, S4, C2, G0, K50**

We suggest you note down the settings, so that you can easily return to them.

To return to measurement mode:-

Type **Q** then press **ENTER**

All of the above settings are explained in the following sections.

## 10.7 Changing a setting

To change a setting, refer to the sections below, enter the command of the new setting required, followed by **ENTER**. The new setting will be sent as a message by the WindSonic.

For example, to change the message format to NMEA, Type **M** **5** and press **ENTER**

The WindSonic will reply **M5**. When the unit is returned to the Measurement mode, it will be in NMEA format.

### Notes:

The factory-set (default) settings are shown in **bold** in the following sections.

To Change E Command setting refer to **Safe Mode** operation, Para's 7.5 and 7.6.

## 10.7.1 Command List

COMMAND	USER
B	Baud rate
C	Analogue angle wrapping
D	Diagnostic and Configuration
E	Set Physical Comms
F	Data and Parity Options
G	Not currently used
H	Power-Up message
K	Minimum Direction Velocity
L	Message Terminator
M	Message Format
N	Unit ID
O	ASCII Output format
P	Output rate
Q	MEASUREMENT MODE
S	Analogue output range
T	Analogue output type
U	Select Units
Y	Analogue Output, Error Status Condition
*	INTERACTIVE MODE

## Bx - Baud rate

Item	Options	Command
Baud rate	2400	B1
	4800	B2
	<b>9600</b>	<b>B3</b>
	19200	B4
	38400	B5
<p>To change the Baud rate when using HyperTerminal: -</p> <p>E.g. If set to B3 (9600 baud) and it is required to set to Baud rate to B2 (4800 baud). Type <b>[F8]</b> to enter Configuration Mode. Type <b>[B]</b> <b>[2]</b> and press <b>[ENTER]</b>. (<b>Do not type any further commands at this stage</b>). Close the 9600 Baud HyperTerminal connection. Open HyperTerminal and set the new connection Baud Rate to 4800 baud. Type <b>[B]</b> and press <b>[ENTER]</b>, the letter B will be shown followed by Capitol B2 Type <b>[Q]</b> and press <b>[ENTER]</b>, data will scroll at the new baud rate.</p>		

## Cx - Analogue settings

The following command is only valid for the WindSonic Option 3:

Item	Options	Command
Analogue Wraparound (Chart recorder facility)	Wrap around      0 – 539°	C1
	<b>Normal</b> <b>0 - 359°</b>	<b>C2</b>

## Dx - Diagnostic and Configuration Command (See Section 10.8)

## Ex - Communications Protocol

Item	Options	Command
Communications protocol	RS422 / RS485 (point to point)	E2
	RS232	E3
To change settings refer to Connecting to a PC (Para's 7.5 and 7.6).		

Option 1 unit default setting will be E3

Option 2 and 3 unit default setting will be E2

**Fx - Data and parity options**

Item	Options	Command
Data and parity options	8 bits, no parity	<b>F1</b>
	8 bits, even parity	F2
	8 bits, odd parity	F3

**Gx - (To be allocated for future developments)**

Item	Options	Command
To be allocated	Not Applicable	Gx

**Hx - Power-up Message**

Item	Options	Command
Power –up message	ON	<b>H1</b>
	OFF	H2
<p>If the power up message is On, then a message similar to that below is output, whenever the unit goes into Measurement mode (i.e. when power is first applied to the unit, or unit returns to Measurement mode from Configuration mode).</p> <p>WINDSONIC (Gill Instruments Ltd) 2368-110-01 RS485/RS422 (CFG) CHECKSUM ROM:E15C E15C *PASS* CHECKSUM FAC:0A42 0A42 *PASS* CHECKSUM ENG:12BE 12BE *PASS* CHECKSUM CAL:C980 C980 *PASS*</p> <p>If any of these checksums fail, the word PASS will be replaced by FAIL and the unit will use its default settings. If the checksum repeatedly fails after power on – contact your supplier.</p> <p><b>NOTE:</b> The exact message above may vary.</p>		

**Kxx to Kxxxx - Minimum Direction Velocity**

Item	Options	Command
Minimum Direction Velocity	0.05m/s to 5m/s	<b>K50</b> KXX to KXXXX
<p>This feature allows the minimum wind velocity to be set at which display of the direction is enabled in thousandth of a metre per second. The default is 50, which means that any wind magnitude less than 0.05m/s will have the wind direction omitted in Comma Separated Variable mode.</p> <p>E.g. Q,,000.04,M,3C.</p> <p>Or last wind reading at 0.05m/s or above repeated in Fixed Field Mode.</p> <p>E.g. Q,237,000.04,M,3C.</p>		

**Lx - Message Terminator**

Item	Options	Command
Message terminator	<CR> <LF>	<b>L1</b>
	<CR>	L2

**Mx to Mxx - Message Format**

Item	Options	Command	
Message Format	Gill, UV, Continuous	M1	
	<b>Gill, Polar, Continuous</b>	<b>M2</b>	
	Gill, UV, Polled	M3	
	Gill, Polar, Polled	M4	
	NMEA, IIMWV (NMEA status code)	M5	
	Tunnel Continuous	M12	
	NMEA, WIMWV (NMEA status code)	M14	
	NMEA, WIMWV (Gill status code)	M15	
	NMEA, IIMWV (Gill status code)	M16	

**Nx - Node Address**

Item	Options	Command
Node Address	<b>Q... -(A to Z)</b>	<b>N&lt;Q&gt;</b>

If used in polled mode then it is recommended that ID's A to F and K, M, N and P are not used, as these characters can be present in the data string.

## Ox - ASCII Output Format

Item	Options	Command
ASCII output format	Comma separated format (CSV)	O1
	Fixed field	O2

Example data string for CSV data changing to low wind less than 0.05m/s (set for K50) and error status code condition.

⌈ Q,156,000.05,M,00,⌋ 19

⌈ Q,,000.04,M,00,⌋ 2A (low wind, no direction figure output at 0.04m/s or lower).

⌈ Q,100,000.09,M,00,⌋ 16

⌈ Q,,,M,04,⌋ 24 (error data, no figures output in wind fields).

Example data string for Fixed Field data changing to low wind less than 0.05m/s (set for K50) and error status code condition.

⌈ Q,160,000.05,M,00,⌋ 1C

⌈ Q,160,000.04,M,00,⌋ 1D (low wind, last direction figure at 0.05m/s or above retained).

⌈ Q,170,000.06,M,00,⌋ 1E

⌈ Q,999,999.99,M,04,⌋ 0A (error data, wind fields padded with 9's).

## Px to Pxx - Output Rate

Item	Options	Command
Output rate	1 per second	P1
	2 per second	P2
	4 per second	P3
	1 reading every 4 seconds	P20
	1 reading every 2 seconds	P21

## Q - Measurement Mode

See Section 10.5.

## Sx - Analogue Output Range

The following command is only valid for the WindSonic Option 3:

Item	Options	Command
Analogue Range, Magnitude Scaling (Set Analogue Output Range)	0 – 5 metres per second	S1
	0 – 10 metres per second	S2
	0 – 20 metres per second	S3
	<b>0 – 30 metres per second</b>	<b>S4</b>
	0 – 40 metres per second	S5
	0 – 50 metres per second	S6
	0 – 60 metres per second	S7
	Analogue output disabled	S9

## Tx - Analogue Output Type (Voltage or Current)

The following command is only valid for the WindSonic Option 3:

Item	Options	Command
Voltage or Current output (Set Analogue Output Type)	<b>0 - 5 Volt</b>	<b>T1</b>
	4 – 20 mA	T3
	0 – 20 mA	T5

## Ux - Output Units

Item	Options	Command
Output Units	<b>Metres per second (M)</b>	<b>U1</b>
	Knots (N)	U2
	Miles per hour (P)	U3
	Kilometres per hour (K)	U4
	Feet per minute (F)	U5

## Yx – Analogue Output, Error Status Condition

Item	Options	Command
Output Level	<b>Full Scale level toggling</b>	<b>Y1</b>
	Fixed Steady level	Y2 nnn
	Pre-Set level toggling	Y3 nnn

Where nnn =000 to 200 see Para 9.7.10.

**NOTE:** This command is not applicable to WindSonic 75 analogue output units.

## 10.8 Configuration / Diagnostic Information

Each of these commands causes a response from the WindSonic.

Item	Command	Response
Type and serial No.	D1	Y16120001
Software version	D2	2368-110-01
Unit configuration	D3	M2,U1,O1,L1,P1,B3,H1,NQ,F1,E2,T1,S4,C2,G0,K50,
Supply Voltage	D5	+11.7v
Self-test	D6	<p><i>See Section 12.2 Self-Test (Still Air)</i></p> <p>ALIGNMENT LIMITS:0D59,0CF5</p> <p>ALIGNMENT U:0D15 *PASS*</p> <p>ALIGNMENT V:0D16 *PASS*</p> <p>CHECKSUM ROM:AB7D AB7D *PASS*</p> <p>CHECKSUM FAC:04F4 04F4 *PASS*</p> <p>CHECKSUM ENG:082A 082A *PASS*</p> <p>CHECKSUM CAL:A9C1 A9C1 *PASS*</p>
Hardware Configuration	D10	<p>Serial Number : Y16120001</p> <p>Software Version : 2368-110-01</p> <p>Class : WINDSONIC (Gill Instruments Ltd)</p> <p>Number of axes on this unit : 2</p> <p>Axes tilted 45deg to horizontal plane</p> <p>Analogue outputs: 2 (12bit)</p> <p>Analogue output modes: 0-5V 4-20mA 0-20mA</p> <p>Maximum output rate: 004Hz</p> <p>Maximum base rate on this unit is 16Hz sampling</p> <p>Available baud rates: 002400 004800 009600 019200 038400</p> <p>Available messages: M1 M2 M3 M4 M5 M12 M14 M15 M16</p> <p>Safe mode enabled</p> <p>Parity control allowed: F1 F2 F3</p> <p>Communication modes: RS232 RS485/422</p>

## 11 MAINTENANCE & FAULT-FINDING

### 11.1 Cleaning

If there is any build-up of deposit on the unit, it should be gently cleaned with a cloth moistened with soft detergent. Solvents should not be used, and care should be taken to avoid scratching any surfaces. The unit must be allowed to defrost naturally after being exposed to snow or icy conditions, do NOT attempt to remove ice or snow with a tool.

**Do NOT remove black “rubber” transducer caps.**

### 11.2 Servicing

There are no moving parts or user-serviceable parts requiring routine maintenance.

Opening the unit or breaking the security seal will void the warranty and the calibration.

In the event of failure, prior to returning the unit to your authorised Gill distributor, it is recommended that:

1. All cables and connectors are checked for continuity, bad contacts, corrosion etc.
2. A bench test is carried out as described in Section 12.1.
3. You contact your supplier for advice

### 11.3 Fault Finding

Symptom	Solution
No output	<p>Check DC power to WindSonic, cable and connections.</p> <p>Check comms settings of WindSonic and host system match, including correct Com port</p> <p>Check unit is in Continuous mode</p> <p>Check that in-line communication devices are wired correctly.</p> <p>NOTE: It is usual for Anemometer TX + to be connected to converter device RX +</p>
Corrupted output	<p>Check comms settings of WindSonic and host system match.</p> <p>Try a slower baud rate.</p> <p>Check cable lengths and type of cable.</p>
One way communication	<p>Check WindSonic and host system are both set to the same protocol RS232, RS422, or RS485.</p> <p>Check wiring is in accordance with the manual.</p>
Failed / Incorrect WindSonic output, data invalid flag	<p>Check that transducer path is not blocked</p>

## 11.4 Returning Unit

If the unit has to be returned, it should be carefully packed in the original packaging and returned to your authorised Gill distributor, with a full description of the fault condition.

## 11.5 Status

The Status code is sent as part of each wind measurement message.

Code	Status	Condition
<b>00</b>	<b>OK</b>	<b>Sufficient samples in average period</b>
01	Axis 1 failed	Insufficient samples in average period on U axis
02	Axis 2 failed	Insufficient samples in average period on V axis
04	Axis 1 and 2 failed	Insufficient samples in average period on both axes
08	NVM error	NVM checksum failed
09	ROM error	ROM checksum failed
A	-	NMEA data Acceptable
V	-	NMEA data Void

## 12 TESTS

### 12.1 Bench test

1. Couple the WindSonic to the host system and power supply, using a known working test cable.
2. Check that the unit is correctly configured by going into Configuration mode and using **D3** See Section 10.6 Checking the configuration.
3. Check for normal output data, and that the Status Code is OK – 00 (or A for NMEA format).
4. If the status code is other than 00 or A, refer to Section 11.5 Status (error) codes.
5. Use an office fan or similar to check that the unit is sensing wind, turning the unit to simulate changing wind direction and to check that both axes are functioning.
6. Note that this is a quick functional test. There are no calibration adjustments; the unit is designed NOT to require re-calibration within its lifetime.

## 12.2 Self-Test (Still Air)

This test checks Alignment and Checksums.

**Alignment tests:** The unit performs a transducer geometry check and compares the result with its factory setting.

**Checksum tests:** The unit performs a check of its program and data memory.

**Important.** *This test is a stringent laboratory test, which will only be passed if carried out under still air conditions at room temperature (17-23°C).*

1. Use the original packing box (inner and outer) to enclose the unit. (The packaging is designed as a zero wind enclosure).
2. Go into Configuration Mode **\* ENTER** .
3. Carry out the Self-test by entering **D 6 ENTER** .

A message similar to that shown below will be generated:

```
ALIGNMENT LIMITS:0D59,0CF5
ALIGNMENT U:OD15 *PASS*
ALIGNMENT V:OD16 *PASS*
CHECKSUM ROM:AB7D AB7D *PASS*
CHECKSUM FAC:04F4 04F4 *PASS*
CHECKSUM ENG:082A 082A *PASS*
CHECKSUM CAL:A9C1 A9C1 *PASS*
```

For each of the Alignment tests a Pass or Refer to Manual message is generated.

For each of the Checksum tests a Pass or Fail message is generated.

4. If any of the tests fail, contact your supplier.

If a “refer to manual” message appears please see Section 11.3 Fault Finding.

**Note that it will only pass if the specified temperature and zero wind conditions are met.**

Check that there are no visible obstructions or damage to the unit before contacting Gill or your authorised distributor for further advice.

### 12.3 Calibration

A Custom calibration is available from Gill Instruments. This must be specified at the time of order or the unit must be returned to Gill Instruments for retrospective calibration.

## 13 APPENDICES

### 13.1 Glossary & Abbreviations

Item	Meaning
CAL	Calibration
CR	Carriage Return
CSV	Comma Separated Variable
ENG	Engineering
FAC	Factory
KPH	Kilometres per Hour
LF	Line Feed
MPH	Miles per Hour
NMEA 0183 (version 3)	National Marine Electronics Association standard for interfacing marine electronic navigational devices
NVM	Non-Volatile Memory
PC	IBM compatible Personal Computer
ROM	Read Only Memory
RS232	Communications standard
RS422	Communications standard
RS485	Communications standard
RXD	Received Data
TXD	Transmitted Data
SDI-12	Serial – Data Interface standard for microprocessor based sensors
WMO	World Meteorological Organisation

### 13.2 Guarantee

For terms of guarantee contact your supplier.

Warranty is void if the coloured security seal is damaged or broken, or the transducer caps have been damaged.

## 13.3 WindSonic Options 1, 2, 3 and 4

### Electrical Conformity

#### EU Declaration of Conformity

We  
Of  
Gill Instruments Limited  
Saltmarsh Park  
67 Gosport Street  
Lymington  
SO41 9EG  
England

In accordance with the following CE Directives:



Hereby declare under our sole responsibility that the following products have been designed and where appropriate, manufactured and tested in accordance with the applicable requirements of the following European harmonised standards and where applicable, IEC Standards:

#### 1405 WindSonic Anemometer

EMC Emissions & Immunity	<b>EN61326-1:2013</b> <b>EN60945:2002</b>
Restriction of Hazardous Substances	<b>EN50581:2012</b>

Signed by:

Print Name: **R. McKay**

Position: **Product Manager**

Date of Issue: **14<sup>th</sup> February 2017**

Place of Issue: **Gill Instruments Ltd, Lymington**

## 14 SDI-12 WindSonic

WindSonic option 4 SDI-12 is factory configured in SDI-12 mode and complies with SDI-12 Interface Standard V1.3, see Section 14.5, SDI-12 Commands for details.

**Note: WindSonic Option 4 is not compatible with Gill Wind or WindView Software.**

### 14.1 WindSonic Option 4 Specification

Output	
Units of measure	Metres/second (m/s)
Output frequency	1 output per second
Digital Parameters or	Polar - Speed and Direction UV - 2 axis, signed Speed
Wind Speed	
Range	0 – 60 m/s
Accuracy	± 2% (at 12m/s)
Resolution	0.01 m/s
Wind Direction	
Range	0 - 359°
Accuracy	± 2° (12m/s)
Resolution	1°
Digital output formats	
Digital Data	SDI-12 V1.3
Averaging	1 Minute Vector, 1 Minute Scalar, 1 Minute Maximum Speed
Anemometer status	
	Status OK and Error codes included as part of standard output message
Environmental	
Moisture protection	IP66
Temperature	Operating -35°C to +70°C Storage -40°C to +80°C
Humidity	Operating <5% to 100%
EMC	EN 61000-6 - 3 (Emissions) EN 61000-6 - 2 (Immunity)
Standards	
	Manufactured within ISO9001: 2008 quality system
Power requirement	
	9.6 – 16 V DC. Current drain <2mA @12v low power operation Current drain <10mA @12v high power operation
Mechanical	
Size / weight	142mm diameter x 160mm 0.5kg
Mounting	Pipe mounting 1.75 inches (44.45mm) diameter
Material	External - Acrylate Styrene Acrylonitrile, Polycarbonate blend.

### 14.2 Cable Type

Application	No. of pairs	Gill ref.	Belden ref.	Batt electronics ref.
SDI-12	2	-	9729	-

### 14.3 Cable Length

WindSonic Option	Communication Format	Baud Rate	Max. Cable Length
Option 4	SDI-12	1200	90m (300ft)

### 14.4 Connecting to an SDI-12 Interface (Option 4)

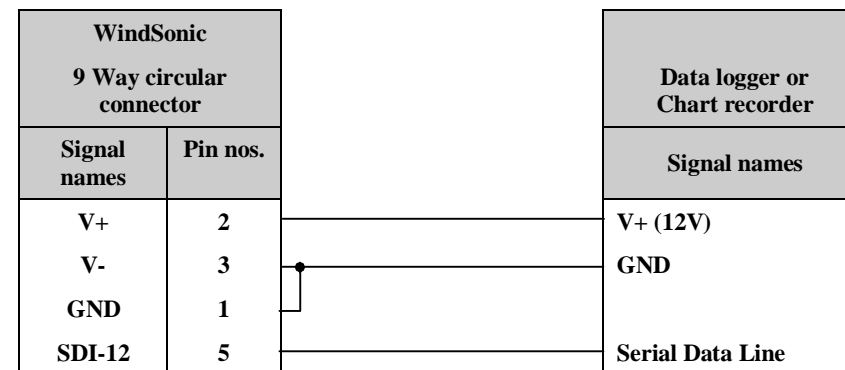



## 14.5 SDI-12 Commands

WindSonic Option 4 complies with SDI-12 Interface Standard V1.3

We advise that you download the full SDI-12 specification from [www.sdi-12.org](http://www.sdi-12.org)

All other commands not defined below respond with a 'zero data values ready' response.

All units of measurement are in metres per second. This cannot be re-scaled.

Wind Measurements are made at 1Hz.

The default operating mode is aXHPM!.

The default unit address is 0 (a or A = unit address).

The unit is set for fixed field operation.

### Commands and Returns in High Power Mode (aXHPM!)

When in high power continuous mode, Wind data (Polar or Axis format) will be logged internally at 1Hz such that a 1-minute rolling average and 1 minute maximum (with associated direction) can be retrieved at any time.

1 minute averaged outputs are available using aR2!, aR3!, aR4! and AR5! Commands.

**NOTE:** When powering up the unit wait 9.5 seconds before sending a command.

Name	Command	Gill Output
Continuous Measurement (Polar)	aR0!	a<dir><mag><status><CR><LF> e.g. 0+332+000.04+00<CR><LF>
Continuous Measurement with CRC (Polar)	aRC0!	a<dir><mag><status><CRC><CR><LF> e.g. 0+272+000.02+00Ldg<CR><LF>
Continuous Measurement (UV)	aR1!	a<U><V><status><CR><LF> e.g. 0-000.03-000.01+00<CR><LF>
Continuous Measurement with CRC (UV)	aRC1!	a<U><V><status><CRC><CR><LF> e.g. 0+000.00-000.01+00DUx<CR><LF>
Averaged vector (UV) data converted to polar direction and magnitude. Scalar magnitude maximum and direction associated with that maximum	aR2!	a<dir_from_vectorav><mag_from_vectorav><dir_at_mag_scalarmax><mag_scalarmax><status><CR><LF> > e.g. 0+090+000.02+123+000.12+00<CR><LF>
Averaged vector (UV) data converted to polar direction and magnitude. Scalar magnitude maximum and direction associated with that maximum with CRC	ARC2!	a<dir_from_vectorav><mag_from_vectorav><dir_at_mag_scalarmax><mag_scalarmax><status><checksum><CR><LF> e.g. 0+090+000.02+123+000.12+00Hv <CR><LF>
U and V values from the averaged vector (UV) data. Scalar magnitude maximum and direction associated with that maximum converted into U and V components.	AR3!	a<U_vectorav><V_vectorav><U_from_scalarmax><V_from_scalarmax><status><CR><LF>  e.g. 0+000.00+000.02+000.07+000.10+00<CR><LF>

Name	Command	Gill Output
U and V values from the averaged vector (UV) data. Scalar magnitude maximum and direction associated with that maximum converted into U and V components with CRC	ARC3!	a<U_vectorav><V_vectorav><U_from_scalarmax><V_from_scalarmax><status><checksum><CR><LF>  e.g. 0+000.00+000.02+000.07+000.10+00JMJ<CR><LF>
Scalar average direction and magnitude	AR4!	a<dir_scalarav><mag_scalarav><dir_at_mag_scalarmax><mag_scalarmax><status><CR><LF> e.g. 0+062+000.04+123+000.12+00<CR><LF>
Scalar average direction and magnitude with CRC	ARC4!	a<dir_scalarav><mag_scalarav><dir_at_mag_scalarmax><mag_scalarmax><status><checksum><CR><LF> > e.g. 0+070+000.03+123+000.12+00JFr<CR><LF>
Scalar average direction and magnitude, then converted into U and V components.	AR5!	a<U_from_scalarav><V_from_scalarav><U_from_scalarmax><V_from_scalarmax><status><CR><LF> e.g. 0-000.01+000.03+000.07+000.10+00<CR><LF>
Scalar average direction and magnitude, then converted into U and V components with CRC.	ARC5!	a<U_from_scalarav><V_from_scalarav><U_from_scalarmax><V_from_scalarmax><status><checksum><CR><LF>  e.g. 0+000.00+000.03+000.07+000.10+00EJ<CR><LF>
Start Measurement (Polar)	aM!	atttn<CR><LF> e.g. a0003
Send Data	aD0!	a<dir><mag><status><CR><LF> e.g. 0+083+000.02+00<CR><LF>
Start Measurement (UV)	aM1!	atttn<CR><LF> e.g. a0003
Send Data	aD0!	a<U><V><status><CR><LF> e.g. 0+000.00+000.02+00<CR><LF>
Start Measurement with CRC (Polar)	aMC!	atttn<CR><LF> e.g. a0003
Send Data	aD0!	a<dir><mag><status><CRC><CR><LF> e.g. 0+295+000.01+00B{T<CR><LF>
Start Measurement with CRC (UV)	aMC1!	atttn<CR><LF> e.g. a0003
Send Data	aD0!	a<U><V><status><CRC><CR><LF> e.g. 0+000.00+000.00+00JZY<CR><LF>
Acknowledge Active	a!	a<CR><LF> e.g. 0<CR><LF>
Send Identification	aI!	a13GillInst 2487 B06<sn><CR><LF> e.g. 013GillInst 2487B0611220012<CR><LF>
Change Address	aAb!	b<CR><LF> e.g. 1<CR><LF>
Address Query	?!	a<CR><LF> e.g. 0<CR><LF>
Measurement on demand	aXLP!	0LP<CR><LF>
Continuous Reading	aXHPM!	0HP<CR><LF>

## Commands and Returns in Low Power Mode (aXLPM!)

Note:- Rolling average data not available.

Use of the aR2!, aR3!, aR4! and aR5! (and their associated aRCn!) commands when the device is in aXLPM! (low power - continuous) mode, will return a "zero data values ready" message.

Name	Command	Gill Output
Not Applicable	aR0!	Zero Data values ready e.g. 0<CR><LF>
Not Applicable	aRC0!	Zero Data values ready e.g. 0AP@<CR><LF>
Not Applicable	aR1!	Zero Data values ready e.g. 0<CR><LF>
Not Applicable	aRC1!	Zero Data values ready e.g. 0AP@<CR><LF>
Not Applicable	aR2!	Zero Data values ready e.g. 0<CR><LF>
Not Applicable	ARC2!	Zero Data values ready e.g. 0AP@<CR><LF>
Not Applicable	AR3!	Zero Data values ready e.g. 0<CR><LF>
Not Applicable	ARC3!	Zero Data values ready e.g. 0AP@<CR><LF>
Not Applicable	AR4!	Zero Data values ready e.g. 0<CR><LF>
Not Applicable	ARC4!	Zero Data values ready e.g. 0AP@<CR><LF>
Not Applicable	AR5!	Zero Data values ready e.g. 0<CR><LF>
Not Applicable	ARC5!	Zero Data values ready e.g. 0AP@<CR><LF>
Start Measurement (Polar)	aM!	attn<CR><LF> e.g. a0053 Where a is unit identifier, 005 is measurement time in seconds and 3 is the number of data readings.
Send Data	aD0!	a<dir><mag><status><CR><LF> e.g. 0+083+000.02+00<CR><LF>
Start Measurement (UV)	aM1!	attn<CR><LF> e.g. 00053
Send Data	aD0!	a<U><V><status><CR><LF> e.g. 0+000.00+000.02+00<CR><LF>
Start Measurement with CRC (Polar)	aMC!	attn<CR><LF> e.g. 00053
Send Data	aD0!	a<dir><mag><status><CRC><CR><LF> e.g. 0+295+000.01+00B{T<CR><LF>
Start Measurement with CRC (UV)	aMC1!	attn<CR><LF> e.g. 00053
Send Data	aD0!	a<U><V><status><CRC><CR><LF> e.g. 0+000.00+000.00+00JZY<CR><LF>
Acknowledge Active	a!	a<CR><LF> e.g. 0<CR><LF>
Send Identification	aI!	a13GillInst 2487 B06 <sn><CR><LF> e.g. 013GillInst 2487B0611220012<CR><LF>
Change Address	aAb!	b<CR><LF> e.g. 1<CR><LF>
Address Query	?!	a<CR><LF> e.g. 0<CR><LF>
Measurement on demand	aXLPM!	0LP<CR><LF>
Continuous Reading	aXHPM!	0HP<CR><LF>

## 14.6 Gill Output Message Format

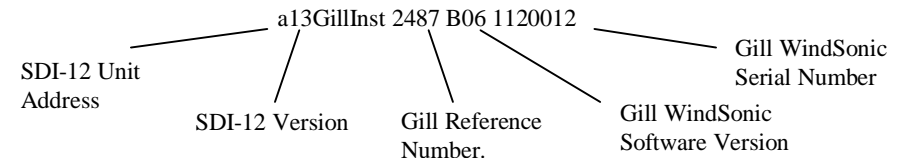

Under normal no error conditions a typical data output will show:-

0+083+000.02+00<CR><LF> e.g. Unit ID, Direction, Speed, Status Code.

Under error conditions e.g. blocked paths error code 04 the unit will pad the wind data with 9's as follows (Gill Fixed Field setting):-

0+999+999.9+04<CR><LF> e.g. Unit ID, Direction, Speed, Status Code.

## 14.7 SDI-12 Status Codes

Code	Status	Condition
00	OK	Sufficient samples in average period
01	Axis 1 failed	Insufficient samples in average period on U axis
02	Axis 2 failed	Insufficient samples in average period on V axis
04	Axis 1 and 2 failed	Insufficient samples in average period on both axes
08	NVM error	NVM checksum failed
09	ROM error	ROM checksum failed
51	Measurement average building	Will be output up to 68 seconds after power up whilst initialisation and 1 minute averaging calculations take place when in High Power mode.



## 14.8 SDI-12 Safe Mode

In the event the unit is not communicating in SDI-12 mode a unit check may be made in RS232 safe mode for fault finding purposes (**applies to units with serial number 11220007 and higher**).

Wire the SDI-12 WindSonic as follows:-

WindSonic Option 4 RS232 Fault Finding Connection		PC 9 Pin D Type Connector Com 1 Port
TX-	8	2
RX-	9	3
GND	1	5
V+	2	V+ PSU
V-	3	V- PSU

**Power to the WindSonic is turned off at this stage.**

Open up a Terminal Program e.g. Tera Term or HyperTerminal etc.

**The Safe Mode settings are:**

Baud Rate	4800
Data bits	8
Parity	None
Stop bits	1
Flow Control	None

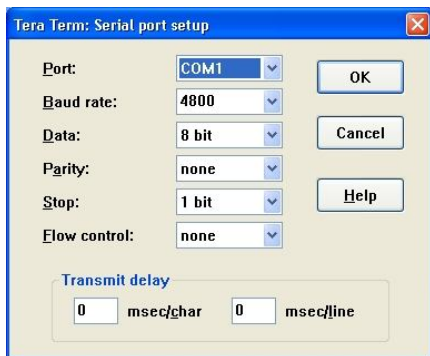

Click on OK.

A blank Terminal screen will now be shown.

Now hold down the \* key on the keyboard (shift and 8) and **switch on power**.

This should place the WindSonic into Safe Mode.

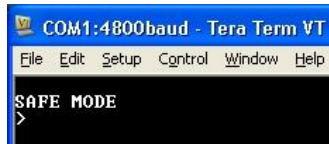
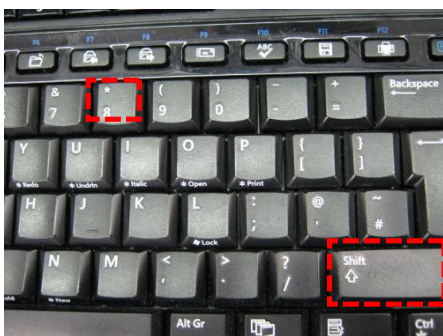

### Unit Checks.

If commands are typed (followed by the Enter key) that the unit will not accept then ILLEGAL COMMAND LINE will be reported.

Commands that will be accepted are:-

REPORT then press Enter key (see below).

SERIAL then press Enter key (see below).

SWVER then press Enter key (see below).

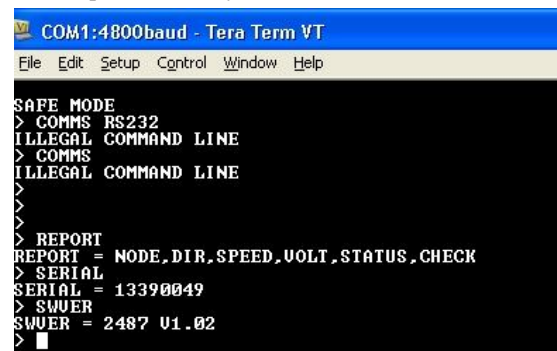

Type Q then press Enter key (see below) this allows data to scroll on screen.

The Wind data string can be examined to check for instance that the wind direction and speed are output and the 2 digit status code is 00.

If the 2 digit Status Code is other than 00 refer to Para 14.7.

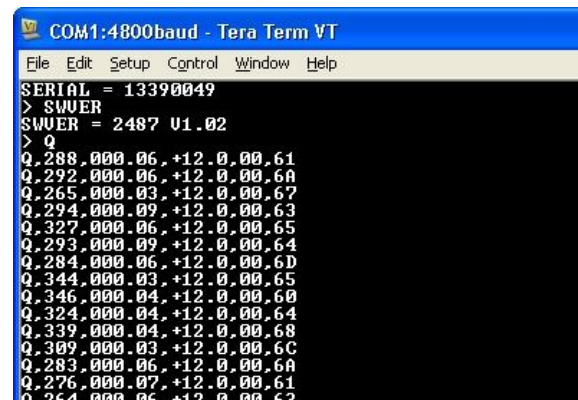

**Note:** Once the unit is turned off and back on again it will return to SDI-12 mode.

If you need to get back into Gill continuous data then you have to perform the safe mode steps again.

## 14.9 WindSonic Option 4 Electrical Conformity

See Para 13.3.